

1393365-1 ✓ ACTIVE

AMP | [Get .64 Connector System](#)

TE Internal #: 1393365-1

Automotive Terminals, Receptacle, Mating Tab Width 1 mm [.039 in], Tab Thickness .025 in [.64 mm], 20 – 18 AWG Wire Size, Get .64 Connector System

[View on TE.com >](#)



Terminals & Splices > Automotive Terminals > GET .64 CONNECTOR SYSTEM, RECEPT AND TAB

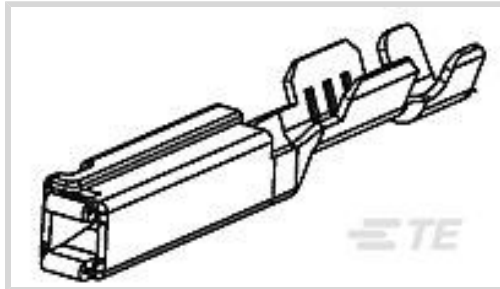

Terminal Type: **Receptacle**

Mating Tab Width: 1 mm [.039 in]

Mating Tab Thickness: .64 mm [.025 in]

Terminal Transmits: 0 – 24 A (Low Power)

Wire Size: 20 – 18 AWG

[All GET .64 CONNECTOR SYSTEM, RECEPT AND TAB \(29\)](#)

## Features

### Product Type Features

Receptacle Style	180°
Sealable	No
Primary Locking Feature	Clean Body

### Contact Features

Typical Current Rating	11 A
Crimp Type	F-Crimp
Terminal Type	Receptacle
Mating Tab Width	1 mm [.039 in]
Mating Tab Thickness	.64 mm [.025 in]
Interface Plating	Gold (Au)
Contact Termination Area Plating Material	Tin (Sn)

### Termination Features

Termination Method to Wire & Cable	Crimp
Product Terminates To	Wire

### Dimensions

Wire Size	.5 – .75 mm <sup>2</sup>
Wire Size Search	18 AWG, 19 AWG, 20 AWG



Wire Insulation Diameter	1.6 – 1.9 mm [.055 – .081 in]
--------------------------	-------------------------------

### Usage Conditions

Insulation Option	Uninsulated
Operating Temperature (Max)	80 °C, 85 °C, 90 °C, 100 °C, 105 °C, 110 °C, 120 °C, 125 °C, 130 °C, 140 °C, 145 °C, 150 °C [176 °F][185 °F][194 °F][212 °F][221 °F][230 °F][248 °F][257 °F][266 °F][284 °F][293 °F][302 °F]
Operating Temperature Range	-40 – 150 °C [-40 – 302 °F]

### Operation/Application

Compatible With Wire Base Material	Copper
------------------------------------	--------

### Packaging Features

Packaging Method	Reel
Packaging Quantity	10000

### Other

Terminal Transmits	0 – 24 A (Low Power)
--------------------	----------------------

## Product Compliance

[For compliance documentation, visit the product page on TE.com>](#)

EU RoHS Directive 2011/65/EU	Compliant
EU ELV Directive 2000/53/EC	Compliant
China RoHS 2 Directive MIIT Order No 32, 2016	No Restricted Materials Above Threshold
EU REACH Regulation (EC) No. 1907/2006	Current ECHA Candidate List: JAN 2022 (223) Candidate List Declared Against: JAN 2022 (223) Does not contain REACH SVHC
Halogen Content	Low Halogen - Br, Cl, F, I < 900 ppm per homogenous material. Also BFR/CFR/PVC Free
Solder Process Capability	Not applicable for solder process capability

#### Product Compliance Disclaimer

This information is provided based on reasonable inquiry of our suppliers and represents our current actual knowledge based on the information they provided. This information is subject to change. The part numbers that TE has identified as EU RoHS compliant have a maximum concentration of 0.1% by weight in homogenous materials for lead, hexavalent chromium, mercury, PBB, PBDE, DBP, BBP, DEHP, DIBP, and 0.01% for cadmium, or qualify for an exemption to these limits as defined in the Annexes of Directive 2011/65/EU (RoHS2). Finished electrical and electronic equipment products will be CE marked as required by Directive 2011/65/EU. Components may not be CE marked. Additionally, the part

numbers that TE has identified as EU ELV compliant have a maximum concentration of 0.1% by weight in homogenous materials for lead, hexavalent chromium, and mercury, and 0.01% for cadmium, or qualify for an exemption to these limits as defined in the Annexes of Directive 2000/53/EC (ELV). Regarding the REACH Regulation, the information TE provides on SVHC in articles for this part number is based on the latest European Chemicals Agency (ECHA) 'Guidance on requirements for substances in articles' posted at this URL: <https://echa.europa.eu/guidance-documents/guidance-on-reach>

## Compatible Parts



TE Part # CAT-G3353-CH8172  
GET .64 CONNECTOR SYSTEM,  
CONNECTOR HSG

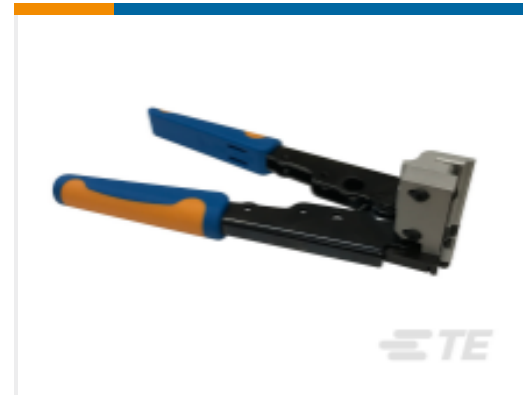

TE Part # 2305570-1  
TERMINAL CUTTER, SIDE FEED



TE Part # 2-1419158-3  
GET MALE TERM, B, AU



TE Part # 2278398-1  
3WAY GET 0.64 SEAL PLUG



TE Part # 2151539-1  
OCEAN-2.0-APPLICATOR-S-  
070F068SP



TE Part # 1411001-6  
SEALED HARN ASSY W CPA KEY B



TE Part # 1924943-1  
PLUG ASSY, 96P GPEC II KEY E RIGHT  
EXIT



TE Part # 2203663-6  
2X9 SEALED PLUG ASSY KEY B  
EXIT



TE Part # 1924939-1  
PLUG ASSY, 96P GPEC II KEY A RIGHT  
EXIT



TE Part # 1-1419168-1  
MARKET 1X6 FEMALE SEALED



TE Part # 1924639-2  
1X8 FEMALE ASSY KEY D, LP LATC



TE Part # 1924941-1  
PLUG ASSY, 96P GPEC II KEY C RIGHT  
EXIT



TE Part # 1452842-3  
22 POS FEMALE HSG ASSY



TE Part # 1411001-7  
2x4 SEALED HARN ASSY W/O CPA



TE Part # 1924944-1  
PLUG ASSY, 96P GPEC II KEY E LEFT  
EXIT



TE Part # 2-2151539-1  
OCEAN-2.0-APPLICATOR-S-  
070F068SP



## Also in the Series | Get .64 Connector System

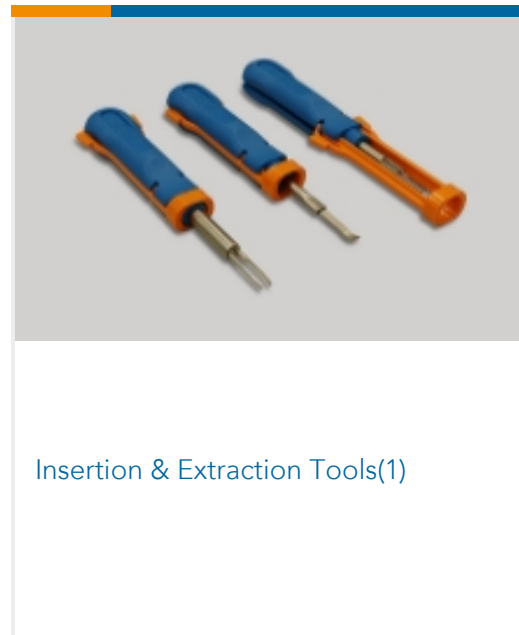
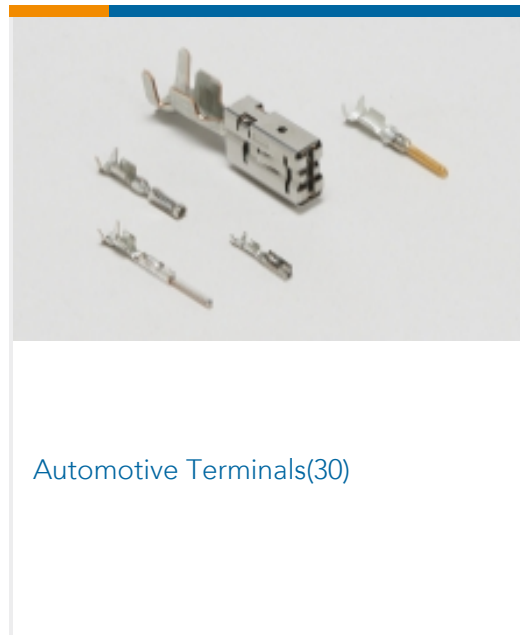
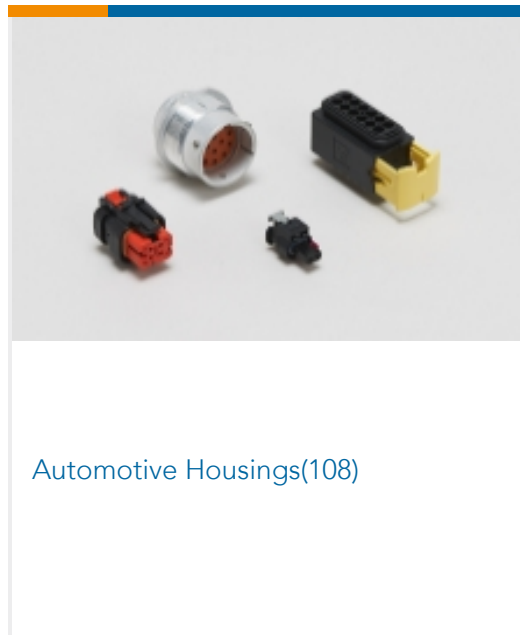
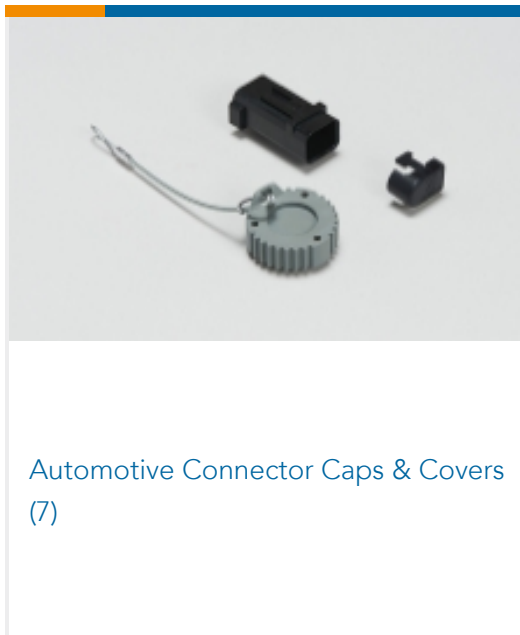

## Customers Also Bought

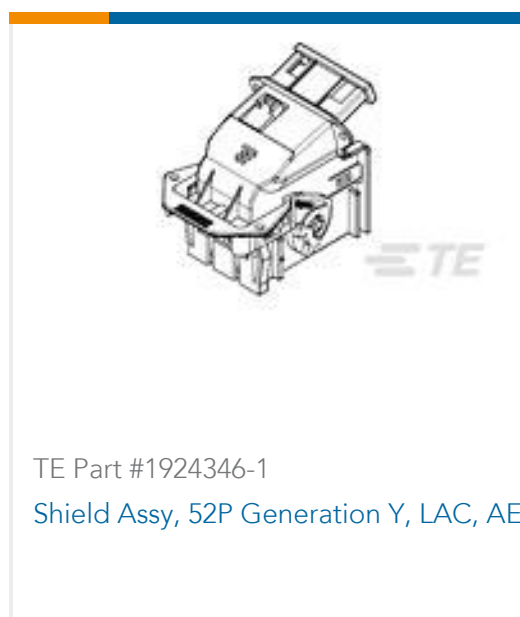
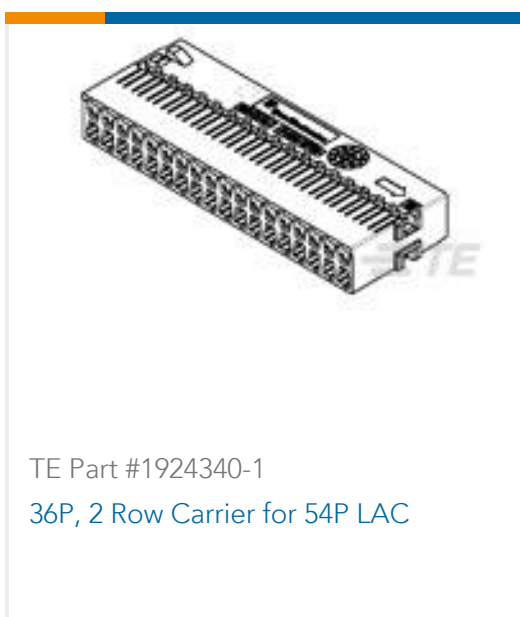



TE Part #771113P005  
FL2500-NO.2-I9-0-27MM



TE Part #1924900-1  
Assy, Plug, 30p Hybrid Key A

## Documents

### Product Drawings

[V23540X7000Y20GET-FEM TERM AU](#)

English

[V23540X7000Y20GET-FEM TERM AU](#)

English

### CAD Files

[3D PDF](#)

3D

Customer View Model

[ENG\\_CVM\\_CVM\\_1393365-1\\_A.2d\\_dxf.zip](#)

English

Customer View Model

[ENG\\_CVM\\_CVM\\_1393365-1\\_A.3d\\_igs.zip](#)

English

Customer View Model

[ENG\\_CVM\\_CVM\\_1393365-1\\_A.3d\\_stp.zip](#)

English

By downloading the CAD file I accept and agree to the [Terms and Conditions](#) of use.

### Datasheets & Catalog Pages

[GET 0.64 Interconnection System](#)

English

### Product Specifications

[Application Specification](#)

English

### Product Environmental Compliance

[MD\\_1393365-1\\_07162015553\\_dmtec](#)

English

[MD\\_1393365-1\\_07162015553\\_dmtec](#)

English

### Instruction Sheets

[Instruction Sheet \(U.S.\)](#)

1393365-1

Automotive Terminals, Receptacle, Mating Tab Width 1 mm [.039 in], Tab Thickness .025 in [.64 mm], 20 – 18 AWG Wire Size, Get .64 Connector System



English