



Ultra-Fast | Ultra-Fast 250

TE Internal #: 2-520102-2

Quick Disconnects, Tab, 22 – 18 AWG Wire Size, .32 – .82 mm² Wire Size, Mating Tab Width .25 in [6.35 mm], Straight, Brass, Ultra-Fast 250

[View on TE.com >](#)

Terminals & Splices > Quick Disconnects

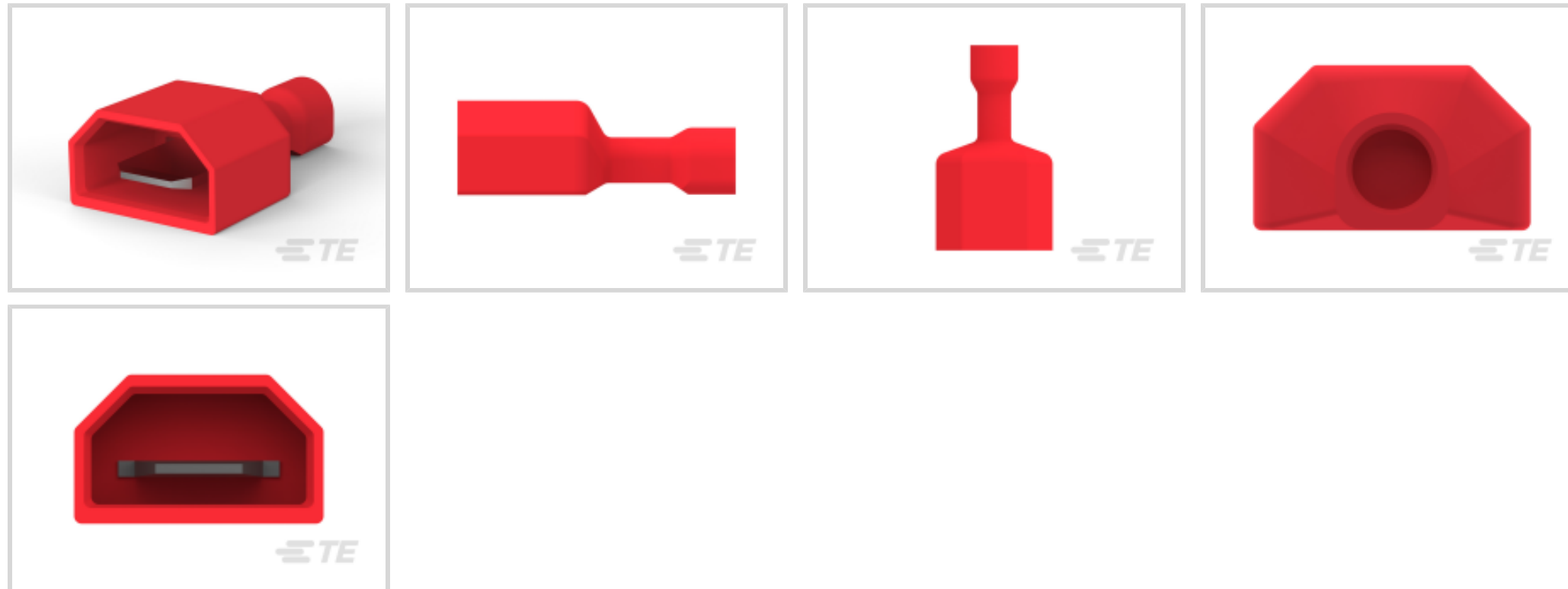

Quick Disconnect Terminal Type: **Tab**

Wire Size: **.32 – .82 mm²**

Mating Tab Width: **6.35 mm [.25 in]**

Mating Tab Thickness: **.81 mm [.032 in]**

Features

Product Type Features

Terminates To	Wire & Cable
Wire/Cable Type	Regular Wire
Wire Stop	No
Insertion Force	Normal
Sealable	No

Configuration Features

Connection Capacity	Single
---------------------	--------

Electrical Characteristics

Voltage (Max)	600 V
---------------	-------

Body Features

Insulation Material	Nylon
---------------------	-------

Contact Features

Quick Disconnect Terminal Type	Tab
Mating Tab Width	6.35 mm [.25 in]

Mating Tab Thickness	.81 mm[.032 in]
Terminal Orientation	Straight
Contact Base Material	Brass
Terminal Plating Material	Tin
Crimp Type	F-Crimp
Barrel Type	Closed

Mechanical Attachment

Mating Retention Type	Dimple
Wire Insulation Support	With

Dimensions

Accepts Wire Insulation Diameter Range	3.43 mm[.135 in]
Receptacle Terminal Stock Thickness	.41 mm[.016 in]
Overall Length	21.75 mm[.855 in]
Wire Size	.32 – .82 mm ²

Usage Conditions

Insulation Option	Uninsulated
Operating Temperature Range	-40 – 110 °C[-40 – 230 °F]

Industry Standards

UL Flammability Rating	UL 94V-2
UL Rating	Listed

Packaging Features

Packaging Quantity	1400
Packaging Method	Strip/Reel

Other

Barrel Color	Red
--------------	-----

Product Compliance

[For compliance documentation, visit the product page on TE.com>](#)

EU RoHS Directive 2011/65/EU	Compliant
EU ELV Directive 2000/53/EC	Compliant
China RoHS 2 Directive MIIT Order No 32, 2016	No Restricted Materials Above Threshold
EU REACH Regulation (EC) No. 1907/2006	



Current ECHA Candidate List: JAN 2022 (223)
 Candidate List Declared Against: JAN 2022 (223)
 Does not contain REACH SVHC

Halogen Content
 Low Halogen - Br, Cl, F, I < 900 ppm per homogenous material. Also BFR/CFR/PVC Free

Solder Process Capability
 Not applicable for solder process capability

Product Compliance Disclaimer

This information is provided based on reasonable inquiry of our suppliers and represents our current actual knowledge based on the information they provided. This information is subject to change. The part numbers that TE has identified as EU RoHS compliant have a maximum concentration of 0.1% by weight in homogenous materials for lead, hexavalent chromium, mercury, PBB, PBDE, DBP, BBP, DEHP, DIBP, and 0.01% for cadmium, or qualify for an exemption to these limits as defined in the Annexes of Directive 2011/65/EU (RoHS2). Finished electrical and electronic equipment products will be CE marked as required by Directive 2011/65/EU. Components may not be CE marked. Additionally, the part numbers that TE has identified as EU ELV compliant have a maximum concentration of 0.1% by weight in homogenous materials for lead, hexavalent chromium, and mercury, and 0.01% for cadmium, or qualify for an exemption to these limits as defined in the Annexes of Directive 2000/53/EC (ELV). Regarding the REACH Regulation, the information TE provides on SVHC in articles for this part number is based on the latest European Chemicals Agency (ECHA) 'Guidance on requirements for substances in articles' posted at this URL: <https://echa.europa.eu/guidance-documents/guidance-on-reach>

Compatible Parts

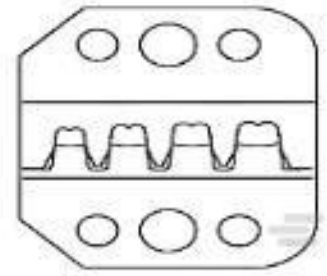

TE Part # 58628-2
 PROCIMP DIESET 26-14 ULTRAFAST



TE Part # 90390-3
 DIES ULTRA-FAST FASTON 22-18 DIE SET



TE Part # 58628-1
 PROCIMP T&D 26-14 ULTRAFAST



TE Part # 2151034-2
 OCEAN_2.0_APPLICATOR-S-1760



TE Part # 2-2151034-2
 OCEAN_2.0_APPLICATOR-S-1760



TE Part # 7-2151034-2
 OCEAN_2.0_APPLICATOR-S-1760



KIT
 REPRESENTATION ONLY

TE Part # 7-2151034-7
 OCEAN_2.0_SPARE_PART_KIT-1760

Also in the Series | **Ultra-Fast 250**



Quick Disconnects(49)

Customers Also Bought

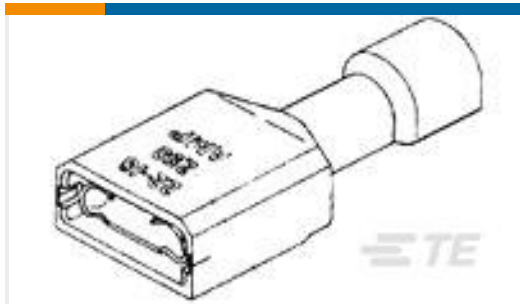

TE Part #2-520263-2
ULTRA-FAST 250 ASY REC 22-18 TPBR

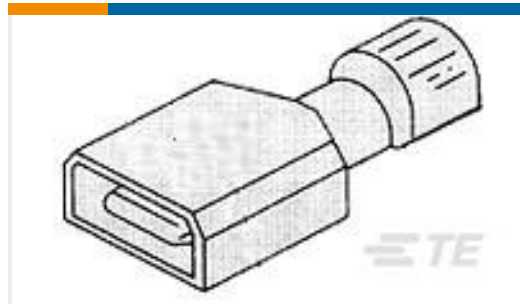

TE Part #3-521142-2
ULTRA-FAST 250 ASY TAB 16-14 AWG TPBR



TE Part #2-520128-2
ULTRA-FAST 250 ASY REC 22-18 AWG TPBR



TE Part #1744001-4
04P MTA156 HDR POL .045SQ TIN

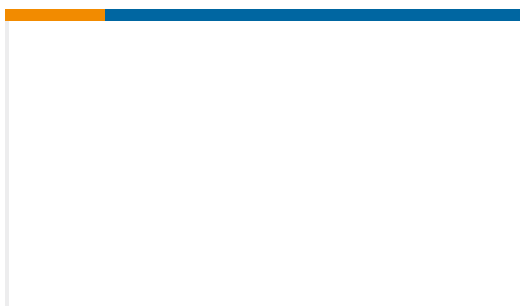

TE Part #1744001-6
06P MTA156 HDR POL .045SQ TIN



TE Part #38061
PISTON SPRING

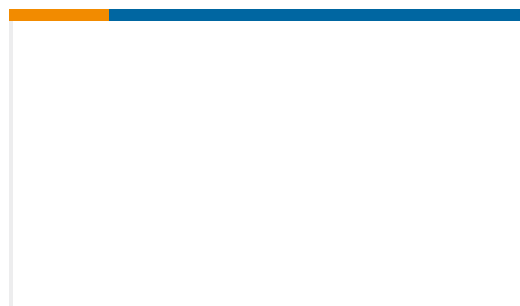

TE Part #5256A
STAINLESS STEEL CLIP



TE Part #7-22280-5
SPRING,COMPRESSION

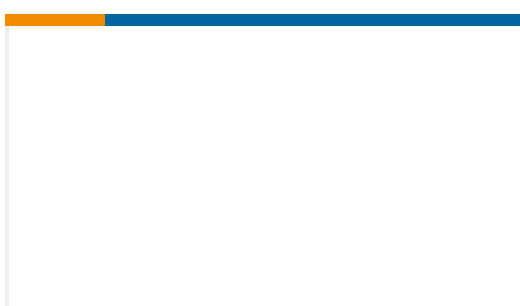

TE Part #A1004CS22P2
CLIP-ON THERMISTOR ASSEMBLY

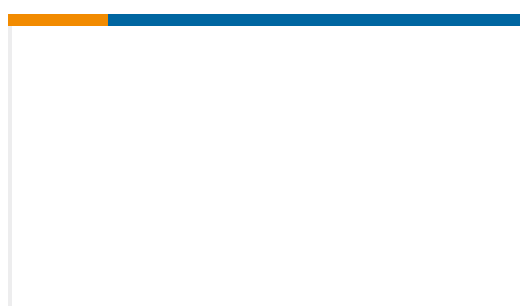

TE Part #D1004PX22P2-F
NTC THERMISTOR ASSEMBLY

Documents

Product Drawings

ULTRA-FAST 250 ASSEMBLY TAB 22-18 AWG BR

English

CAD Files

3D PDF

3D

Customer View Model

ENG_CVM_CVM_2-520102-2_N.2d_dxf.zip



English

Customer View Model

[ENG_CVM_CVM_2-520102-2_N.3d_igs.zip](#)

English

Customer View Model

[ENG_CVM_CVM_2-520102-2_N.3d_stp.zip](#)

English

By downloading the CAD file I accept and agree to the [Terms and Conditions](#) of use.

Datasheets & Catalog Pages

[Ultra-Fast and Ultra Fast Plus](#)

English

Product Specifications

[Application Specification](#)

English

Product Environmental Compliance

[MD_2-520102-2_030420182255_dmtec](#)

English

[MD_2-520102-2_030420182255_dmtec](#)

English

Agency Approvals

[UL](#)

English