

173974-1 ✓ ACTIVE

[Positive Lock](#) | [Positive Lock 187](#)

TE Internal #: 173974-1

Crimp Terminal Housings, Receptacle, Receptacle, 1 Position, Straight, UL 94V-0, Natural, Nylon, Contact Mating Retention, Positive Lock 187

[View on TE.com >](#)



Terminals & Splices > Terminal Housings, Insulation Sleeves & Blocks > Crimp Terminal Housings

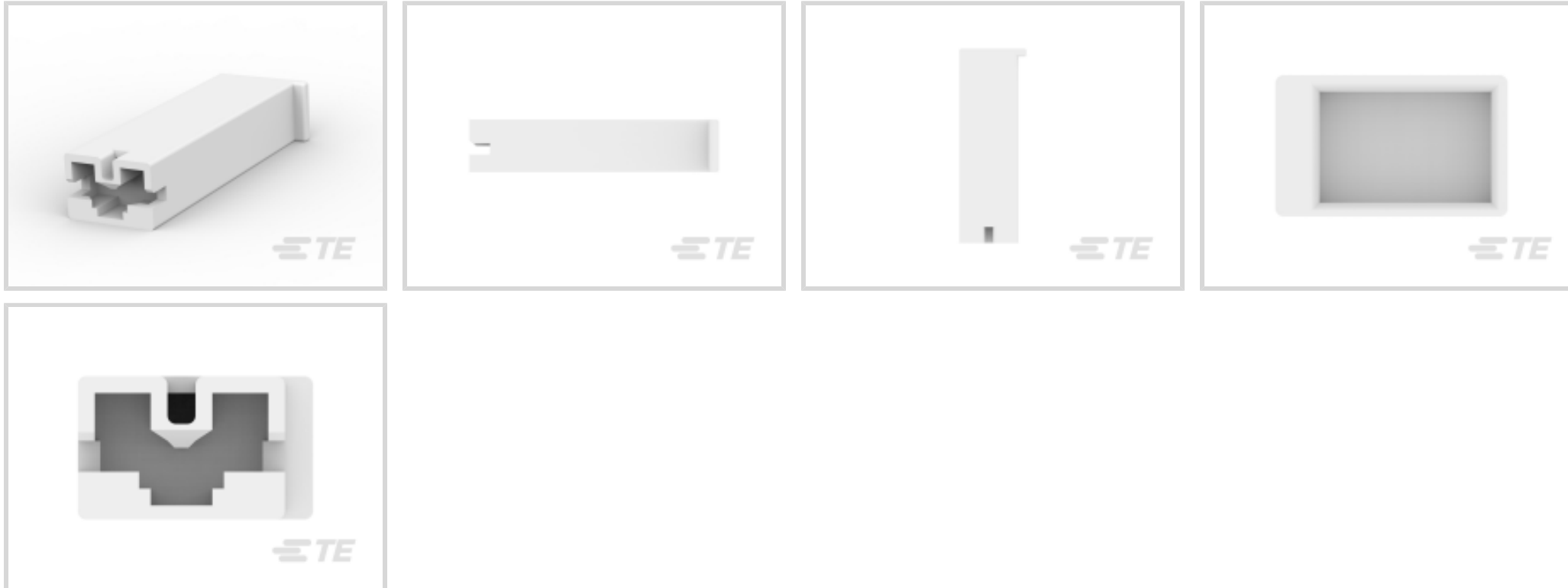

Terminal Type: **Receptacle**

Housing Type: **Receptacle**

Number of Positions: **1**

Terminal Orientation: **Straight**

UL Flammability Rating: **UL 94V-0**

## Features

### Product Type Features

Product Type	Terminal Housing
Sealable	No
Housing Type	Receptacle
Insulated	No

### Configuration Features

Number of Positions	1
---------------------	---

### Body Features

Primary Product Color	Natural
-----------------------	---------

### Contact Features

Terminal Type	Receptacle
Terminal Orientation	Straight
Contact Mating Retention	With

### Mechanical Attachment



Mating Alignment Type	Polarization
Mating Alignment	With
Crimp Terminal Housing Mounting Style	Cable Mount (Free-Hanging)

### Housing Features

Housing Material	Nylon
------------------	-------

### Dimensions

Length	24.3 mm[.956 in]
--------	------------------

### Usage Conditions

Operating Temperature Range	-40 – 105 °C[-40 – 221 °F]
-----------------------------	----------------------------

### Operation/Application

For Use With	187 Series
--------------	------------

### Industry Standards

UL Flammability Rating	UL 94V-0
------------------------	----------

### Packaging Features

Packaging Quantity	1000
--------------------	------

## Product Compliance

[For compliance documentation, visit the product page on TE.com>](#)



EU RoHS Directive 2011/65/EU	Compliant
EU ELV Directive 2000/53/EC	Compliant
China RoHS 2 Directive MIIT Order No 32, 2016	No Restricted Materials Above Threshold
EU REACH Regulation (EC) No. 1907/2006	Current ECHA Candidate List: JAN 2022 (223) Candidate List Declared Against: JAN 2022 (223) Does not contain REACH SVHC
Halogen Content	Low Halogen - Br, Cl, F, I < 900 ppm per homogenous material. Also BFR/CFR/PVC Free
Solder Process Capability	Not applicable for solder process capability

#### Product Compliance Disclaimer



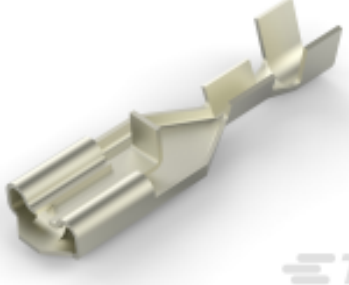
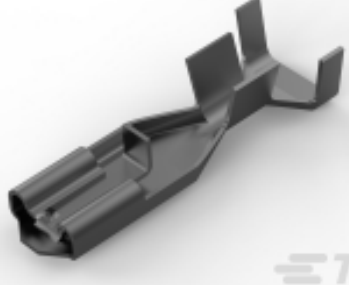
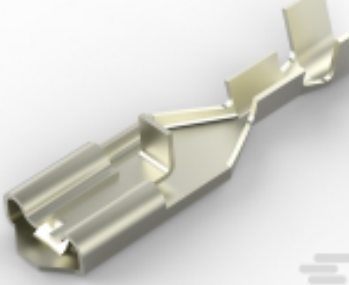
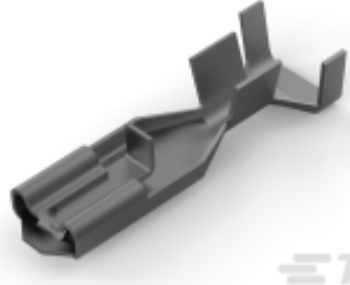
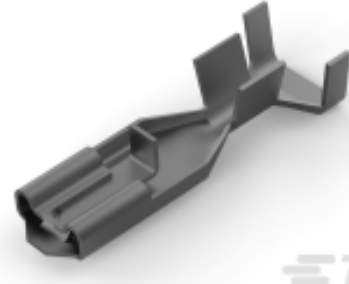
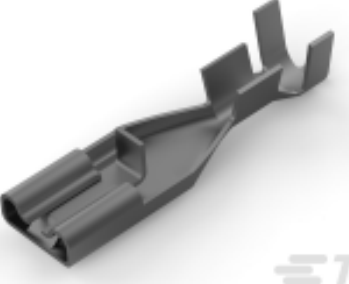
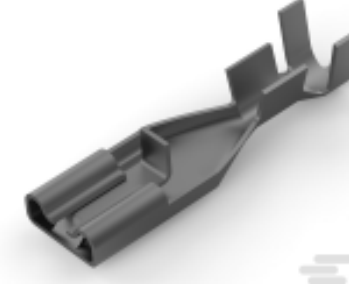
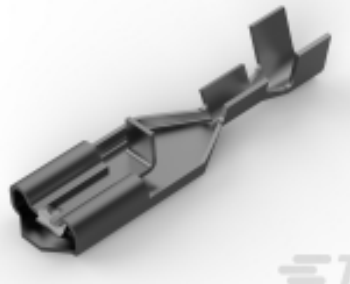

This information is provided based on reasonable inquiry of our suppliers and represents our current actual knowledge based on the information they provided. This information is subject to change. The part numbers that TE has identified as EU RoHS compliant have a maximum concentration of 0.1% by weight in homogenous materials for lead, hexavalent chromium, mercury, PBB, PBDE, DBP, BBP, DEHP, DIBP, and 0.01% for cadmium, or qualify for an exemption to these limits as defined in the Annexes of Directive 2011/65/EU (RoHS2). Finished electrical and electronic equipment products

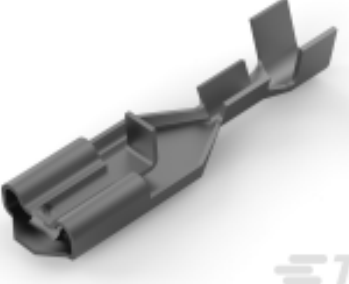
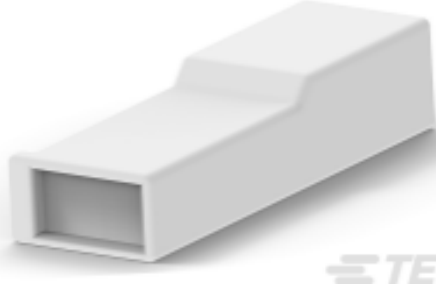
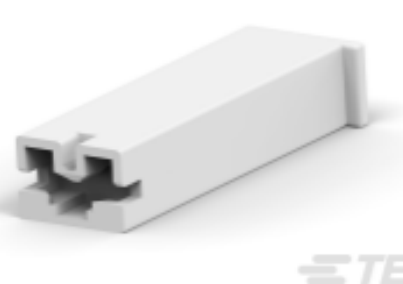
will be CE marked as required by Directive 2011/65/EU. Components may not be CE marked. Additionally, the part numbers that TE has identified as EU ELV compliant have a maximum concentration of 0.1% by weight in homogenous materials for lead, hexavalent chromium, and mercury, and 0.01% for cadmium, or qualify for an exemption to these limits as defined in the Annexes of Directive 2000/53/EC (ELV). Regarding the REACH Regulation, the information TE provides on SVHC in articles for this part number is based on the latest European Chemicals Agency (ECHA) 'Guidance on requirements for substances in articles' posted at this URL: <https://echa.europa.eu/guidance-documents/guidance-on-reach>

## Compatible Parts

 <p>TE Part # 170330-2 PL 187 RECEPTACLE 24-20 AWG NPPHBZ</p>	 <p>TE Part # 170332-1 PL 187 RECEPTACLE 18-14 AWG PTPBR</p>	 <p>TE Part # 170324-2 PL 187 RECEPTACLE 24-20 AWG 0.3 NPCU</p>	 <p>TE Part # 170326-5 187 PL MKII REC. 18-14AWG PTPB</p>
 <p>TE Part # 170326-1 187 PL MKII REC. 18-14AWG PTBR</p>	 <p>TE Part # 170325-5 187 PL MKII REC. 20-16AWG PTBR</p>	 <p>TE Part # 170325-1 187 PL MKII REC. 20-16AWG PTBR</p>	 <p>TE Part # 170324-1 187 PL MKII REC. 24-20AWG PTBR</p>
 <p>TE Part # 170331-1 PL MKII 187 REC 20-16AWG PTBR LP</p>	 <p>TE Part # 170330-1 PL MKII 187 REC 24-20AWG PTBR LP</p>	 <p>TE Part # 1-176448-1 187 POSITIVE LOCK MK-II TAB HSG 1POS</p>	 <p>TE Part # 3-173974-1 PL MKII 187 REC HSG 1P NYLON GWT NAT</p>

## Also in the Series | Positive Lock 187

 <p>Crimp Terminal Housings(87)</p>	 <p>Insertion &amp; Extraction Tools(2)</p>	 <p>Insulation Boots &amp; Sleeves(7)</p>	 <p>Quick Disconnects(56)</p>
------------------------------------------------------------------------------------------------------------------------	--------------------------------------------------------------------------------------------------------------------------------	--------------------------------------------------------------------------------------------------------------------------------	--------------------------------------------------------------------------------------------------------------------

## Customers Also Bought

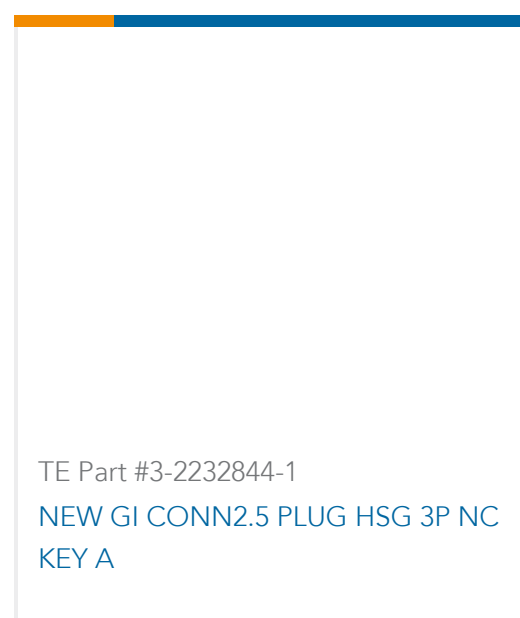
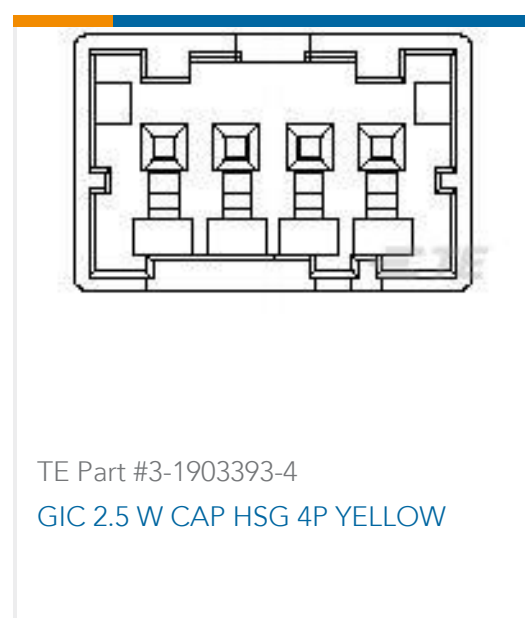
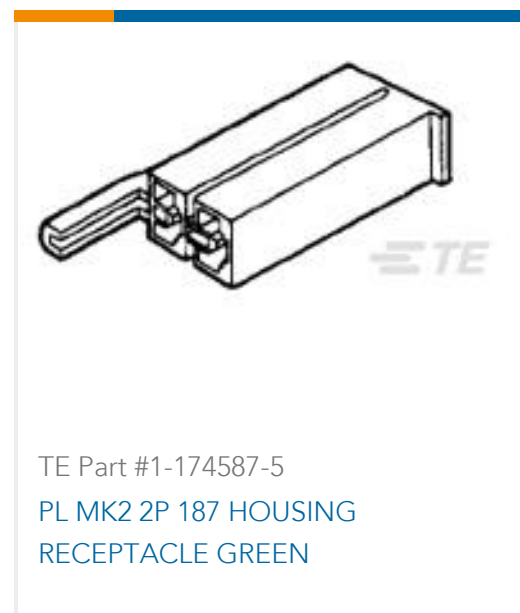

## Documents

### Product Drawings

[187 HSG. PL MKII REC. NAT](#)

English

### CAD Files

[3D PDF](#)

3D

Customer View Model

[ENG\\_CVM\\_CVM\\_173974-1\\_P.2d\\_dxf.zip](#)

English

Customer View Model

[ENG\\_CVM\\_CVM\\_173974-1\\_P.3d\\_igs.zip](#)

English

Customer View Model

[ENG\\_CVM\\_CVM\\_173974-1\\_P.3d\\_stp.zip](#)

English

By downloading the CAD file I accept and agree to the [Terms and Conditions](#) of use.

### Datasheets & Catalog Pages



### Positive Lock Receptacles

English

[POS\\_LOCK\\_MII\\_QRG](#)

English

---

### Product Specifications

[187 SERIES POSITIVE LOCK MARK-II CONNECTOR](#)

Japanese

[Product Specification](#)

Japanese

[Product Specification](#)

English

[JAPANESE](#)

English

---

### Product Environmental Compliance

[MD\\_173974-1\\_11282018358\\_dmtec](#)

English

[MD\\_173974-1\\_11282018358\\_dmtec](#)

English