

174657-2 ✓ ACTIVE

AMP | Econoseal, Econoseal J - Mark II

TE Internal #: 174657-2

Housing for Male Terminals, Wire-to-Wire, 10 Position, .189 in [4.8 mm] Centerline, Sealable, Black, Signal, Cable Mount (Free-Hanging), Hybrid

[View on TE.com >](#)



Connectors > Automotive Connectors > Connector Housings > ECONOSEAL, CONNECTOR HOUSING

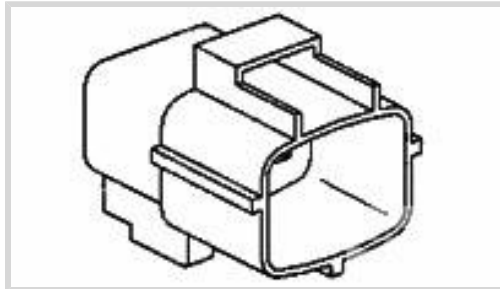

Connector & Housing Type: **Housing for Male Terminals**

Mating Tab Width: **1.8 mm [ .071 in ]**

Connector System: **Wire-to-Wire**

Number of Positions: **10**

Centerline (Pitch): **4.8 mm [ .189 in ]**

[All ECONOSEAL, CONNECTOR HOUSING \(90\)](#)

## Features

### Product Type Features

Connector & Housing Shape	Rectangular
Connector & Housing Type	Housing for Male Terminals
Connector System	Wire-to-Wire
Sealable	Yes
Hybrid Connector	No
Primary Locking Feature	Integrated in Housing

### Configuration Features

Number of Positions	10
Number of Rows	2

### Electrical Characteristics

Operating Voltage	12 VDC
Nominal Voltage Architecture	12 V

### Body Features

Cable Exit Angle	180°
Body Material	PBT
Primary Product Color	Black



### Contact Features

Contact Size	1.8mm
Contact Type	Tab
Mating Tab Width	1.8 mm[.071 in]

### Mechanical Attachment

Mounting Feature	Without
Terminal Position Assurance	Yes
Strain Relief	Without
Mating Alignment Type	Polarizing Rib
Mating Alignment	With
Connector Mounting Type	Cable Mount (Free-Hanging)

### Housing Features

Centerline (Pitch)	4.8 mm[.189 in]
--------------------	-----------------

### Dimensions

Product Width	32.7 mm[1.287 in]
Product Length	36.5 mm[1.437 in]
Product Height	30.7 mm[1.209 in]
Row-to-Row Spacing	3 mm[.118 in]

### Usage Conditions

Operating Temperature (Max)	70 °C, 75 °C, 80 °C, 85 °C, 90 °C, 100 °C, 105 °C[158 °F][167 °F][176 °F][185 °F][194 °F] [212 °F][221 °F]
Operating Temperature Range	-30 – 105 °C[-22 – 221 °F]

### Operation/Application

Circuit Application	Signal
---------------------	--------

### Industry Standards

UL Flammability Rating	UL 94V-2
------------------------	----------

### Packaging Features

Packaging Quantity	100
Packaging Method	Bag

### Other

Serviceable	Yes
-------------	-----



Connector Position Assurance Capable

No

### Product Compliance





[For compliance documentation, visit the product page on TE.com>](#)

EU RoHS Directive 2011/65/EU	Compliant
EU ELV Directive 2000/53/EC	Compliant
China RoHS 2 Directive MIIT Order No 32, 2016	No Restricted Materials Above Threshold
EU REACH Regulation (EC) No. 1907/2006	Current ECHA Candidate List: JAN 2022 (223) Candidate List Declared Against: JAN 2022 (223) Does not contain REACH SVHC
Halogen Content	Not Low Halogen - contains Br or Cl > 900 ppm.
Solder Process Capability	Not applicable for solder process capability

#### Product Compliance Disclaimer

This information is provided based on reasonable inquiry of our suppliers and represents our current actual knowledge based on the information they provided. This information is subject to change. The part numbers that TE has identified as EU RoHS compliant have a maximum concentration of 0.1% by weight in homogenous materials for lead, hexavalent chromium, mercury, PBB, PBDE, DBP, BBP, DEHP, DIBP, and 0.01% for cadmium, or qualify for an exemption to these limits as defined in the Annexes of Directive 2011/65/EU (RoHS2). Finished electrical and electronic equipment products will be CE marked as required by Directive 2011/65/EU. Components may not be CE marked. Additionally, the part numbers that TE has identified as EU ELV compliant have a maximum concentration of 0.1% by weight in homogenous materials for lead, hexavalent chromium, and mercury, and 0.01% for cadmium, or qualify for an exemption to these limits as defined in the Annexes of Directive 2000/53/EC (ELV). Regarding the REACH Regulation, the information TE provides on SVHC in articles for this part number is based on the latest European Chemicals Agency (ECHA) 'Guidance on requirements for substances in articles' posted at this URL: <https://echa.europa.eu/guidance-documents/guidance-on-reach>

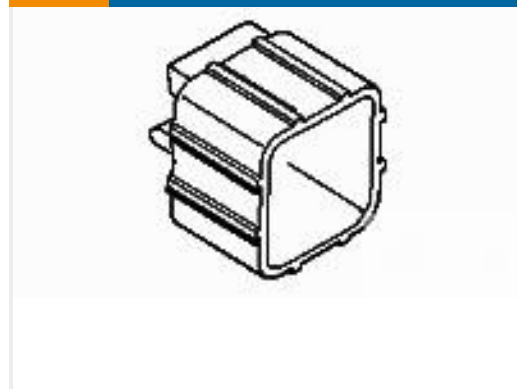
### Compatible Parts

 <p>TE Part # CAT-EC7491-T273 Econoseal Receptacles and Tabs</p>	 <p>TE Part # 171631-2 070 TAB CONT GOLD</p>	 <p>TE Part # 174658-7 10 POS DL PLATE FOR CAP MKII+</p>	 <p>TE Part # 174656-7 10 POS DL PLATE FOR PLUG MKII+</p>
---	--	---	--

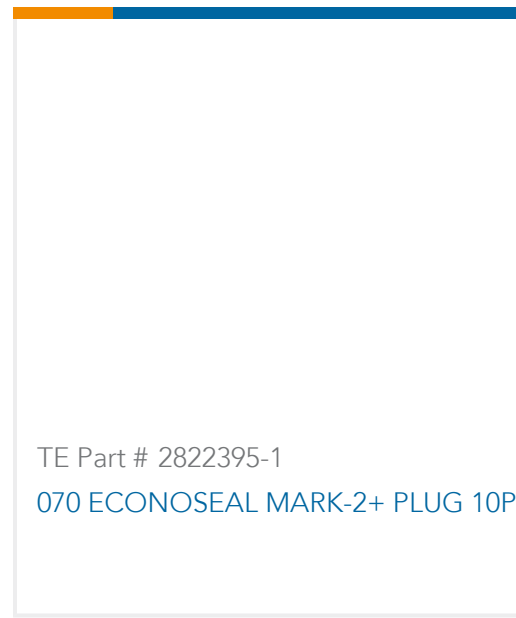

Also in the Series | Econoseal

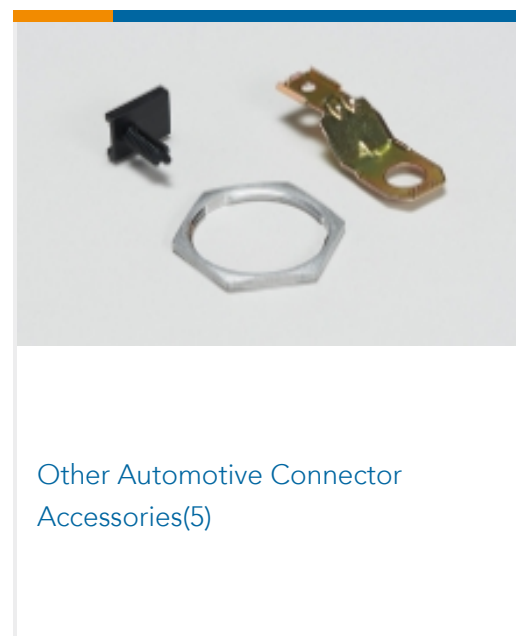
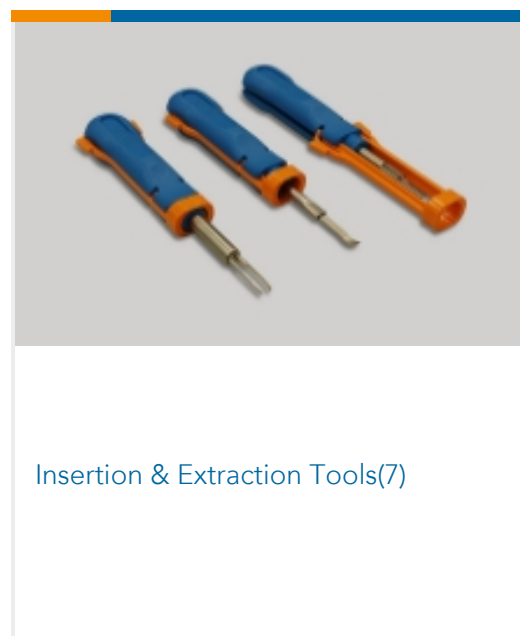
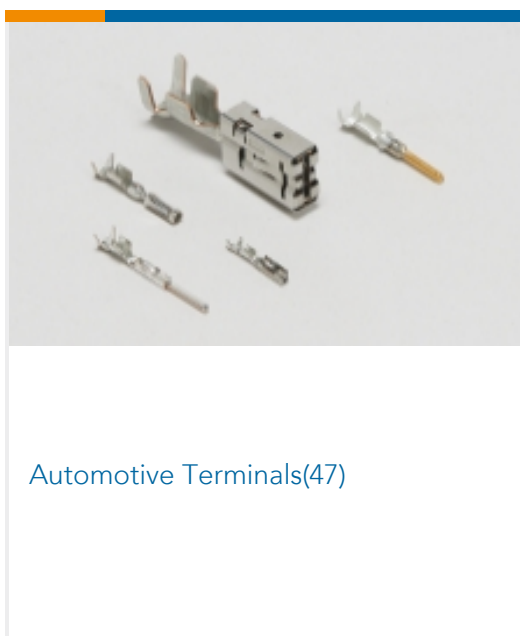
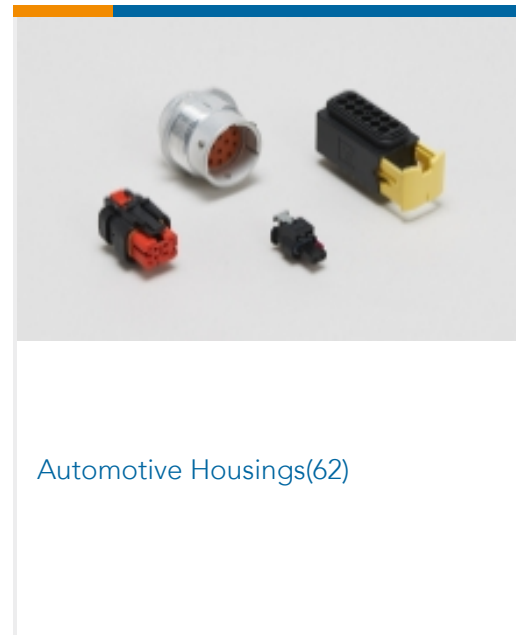
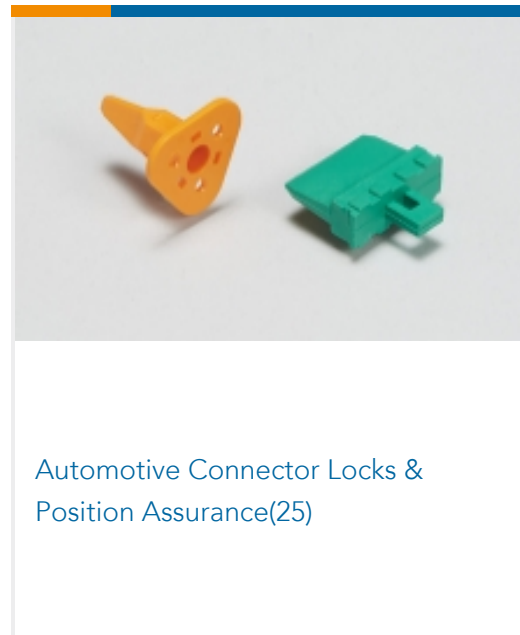
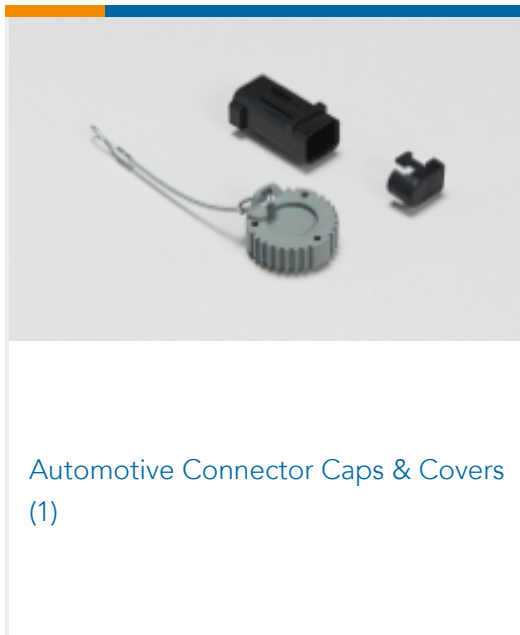

Also in the Series | Econoseal J - Mark II

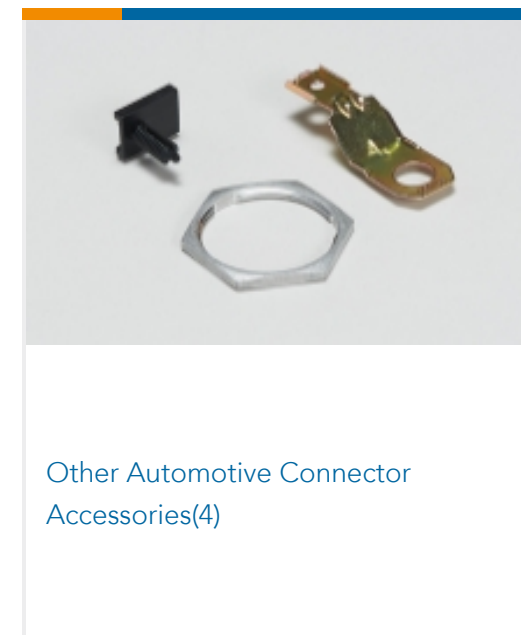
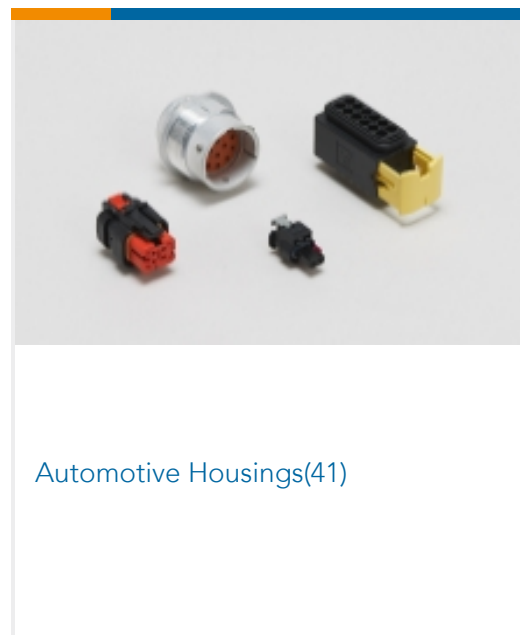

Customers Also Bought

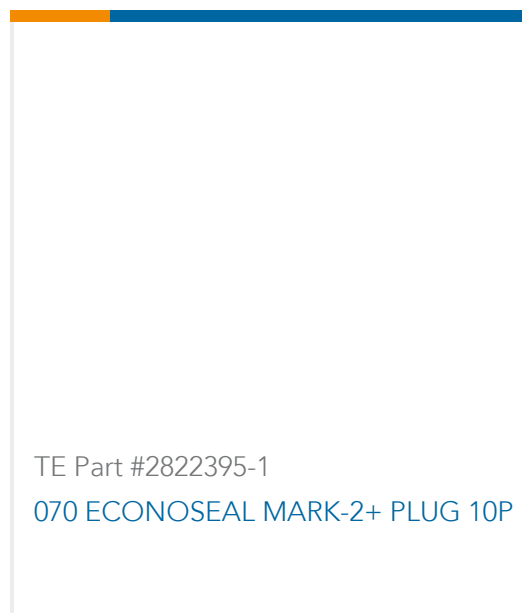
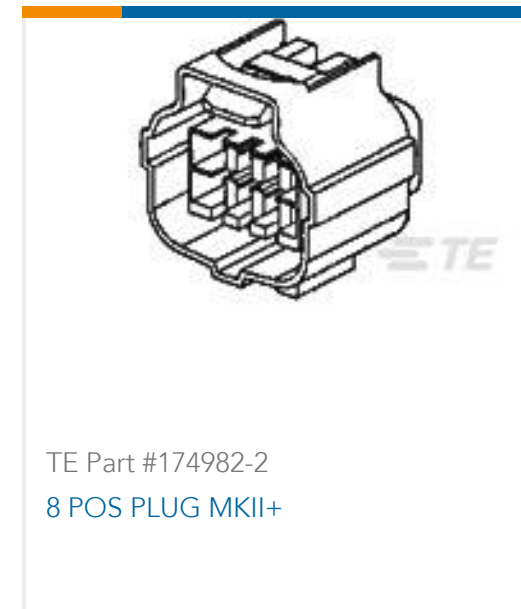
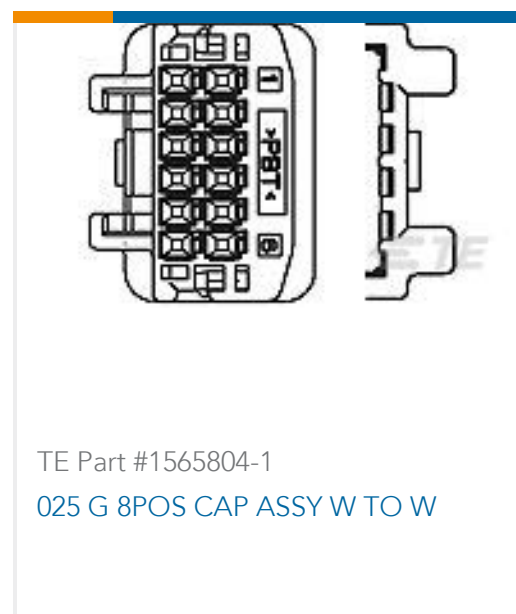

## Documents

### Product Drawings

10 POS. CAP MK II +

English

### CAD Files

3D PDF

English

### Customer View Model

[ENG\\_CVM\\_174657-2\\_B.2d\\_dxf.zip](#)

English

### Customer View Model

[ENG\\_CVM\\_174657-2\\_B.3d\\_igs.zip](#)

English

### Customer View Model

[ENG\\_CVM\\_174657-2\\_B.3d\\_stp.zip](#)

English

By downloading the CAD file I accept and agree to the [Terms and Conditions](#) of use.

## Datasheets & Catalog Pages



## Econoseal Connector Series

English

---

### Product Specifications

#### Product Specification

English

#### Product Specification

Japanese

---

### Product Environmental Compliance

#### Product Compliance

English

#### Product Compliance

English

---

### Instruction Sheets

#### ECONOSEAL J MARK II+ CONNECTOR (EJ-MK II+)

English

#### Customer Manual (non U.S.)

English

#### ECONOSEAL J MARK II+ CONNECTOR

English

#### Customer Manual (non U.S.)

English

---

### Agency Approvals

#### Agency Approval Document

English