



AMP | Sealed Sensor Connector SSC System

TE Internal #: 184140-1

Automotive Seals & Cavity Plugs, Single Wire Seal (SWS), Cavity Diameter .173 in [4.4 mm], Silicone, Poor, 40, Sealed Sensor Connector SSC System

[View on TE.com >](#)

Connectors > Automotive Connectors > Seals & Cavity Plugs

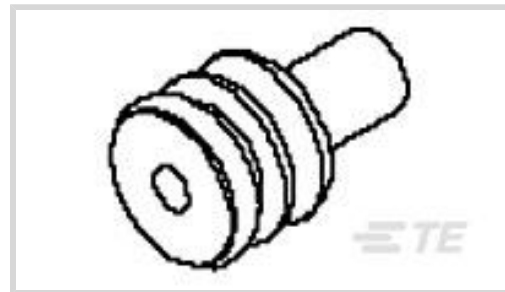

Connector Seal Type: **Single Wire Seal (SWS)**

Cavity Diameter: **4.4 mm [.173 in]**

Accepts Cable Insulation Diameter Range: **1.6 – 2.1 mm [.063 – .083 in]**

Seal Material: **Silicone**

Resistance to Hydrocarbons: **Poor**

Features

Product Type Features

Connector Seal Type	Single Wire Seal (SWS)
---------------------	------------------------

Body Features

Seal Material	Silicone
Primary Product Color	Orange

Dimensions

Cavity Diameter	4.4 mm[.173 in]
Accepts Cable Insulation Diameter Range	1.6 – 2.1 mm[.063 – .083 in]

Usage Conditions

Operating Temperature (Max)	65 °C, 70 °C, 75 °C, 80 °C, 85 °C, 90 °C, 100 °C, 105 °C, 110 °C, 120 °C, 125 °C, 130 °C [149 °F][158 °F][167 °F][176 °F][185 °F][194 °F][212 °F][221 °F][230 °F][248 °F][257 °F][266 °F]
Operating Temperature Range	-40 – 130 °C[-40 – 266 °F]

Industry Standards

UL Flammability Rating	None
------------------------	------

Other

Resistance to Hydrocarbons	Poor
Shore A Hardness	40



Contains Lubricant	Yes
--------------------	-----

Product Compliance

[For compliance documentation, visit the product page on TE.com>](#)

EU RoHS Directive 2011/65/EU	Compliant
EU ELV Directive 2000/53/EC	Compliant
China RoHS 2 Directive MIIT Order No 32, 2016	No Restricted Materials Above Threshold
EU REACH Regulation (EC) No. 1907/2006	Current ECHA Candidate List: JAN 2022 (223) Candidate List Declared Against: JAN 2022 (223) Does not contain REACH SVHC
Halogen Content	Low Halogen - Br, Cl, F, I < 900 ppm per homogenous material. Also BFR/CFR/PVC Free
Solder Process Capability	Not reviewed for solder process capability

Product Compliance Disclaimer



This information is provided based on reasonable inquiry of our suppliers and represents our current actual knowledge based on the information they provided. This information is subject to change. The part numbers that TE has identified as EU RoHS compliant have a maximum concentration of 0.1% by weight in homogenous materials for lead, hexavalent chromium, mercury, PBB, PBDE, DBP, BBP, DEHP, DIBP, and 0.01% for cadmium, or qualify for an exemption to these limits as defined in the Annexes of Directive 2011/65/EU (RoHS2). Finished electrical and electronic equipment products will be CE marked as required by Directive 2011/65/EU. Components may not be CE marked. Additionally, the part numbers that TE has identified as EU ELV compliant have a maximum concentration of 0.1% by weight in homogenous materials for lead, hexavalent chromium, and mercury, and 0.01% for cadmium, or qualify for an exemption to these limits as defined in the Annexes of Directive 2000/53/EC (ELV). Regarding the REACH Regulation, the information TE provides on SVHC in articles for this part number is based on the latest European Chemicals Agency (ECHA) 'Guidance on requirements for substances in articles' posted at this URL: <https://echa.europa.eu/guidance-documents/guidance-on-reach>

Compatible Parts

 <p>TE Part # 184060-1 6 POS./6 CIRC PLUG ASSY, KEY A</p>	 <p>TE Part # 184115-1 12 POS. PLUG ASSY</p>	 <p>TE Part # 184344-1 2X2 PLG ASY KEY A C3</p>	 <p>TE Part # 184006-2 2 POS. PLUG ASSY, KEY D, GRAY</p>
--	--	--	---

 <p>TE Part # 184166-1 2 POS. CAP HSG., KEY D</p>	 <p>TE Part # 184006-1 2 POS. PLUG ASSY, KEY D, GREEN</p>	 <p>TE Part # 184392-2 2X2 PLG ASY, KEY A, W/O CPA C3, natural</p>	 <p>TE Part # 184248-1 2X2 PLG ASY KEY A C4</p>
 <p>TE Part # 184046-1 4 POS. PLUG ASSY, KEY A</p>	 <p>TE Part # 184163-1 2 POS. CAP HSG., KEY A</p>	 <p>TE Part # 184207-1 2 POS. PLUG ASSY, KEY J</p>	 <p>TE Part # 184340-1 PLUG ASSY,2X2,CPA,W/O SLOT,CKT4 BLKD</p>
 <p>TE Part # 184164-1 2 POS. CAP HSG., KEY B</p>	 <p>TE Part # 184004-1 2 POS. PLUG ASSY, KEY C, BLACK</p>	 <p>TE Part # 184165-1 2 POS. CAP HSG., KEY C</p>	 <p>TE Part # 184022-1 2 POS. PLUG ASSY, KEY M, BLACK</p>
 <p>TE Part # 184000-1 2 POS. PLUG ASSY, KEY A, BLACK</p>	 <p>TE Part # 184032-1 3 POS. PLUG ASSY, KEY A</p>	 <p>TE Part # 184042-1 1 POS. PLUG ASSY, KEY A</p>	 <p>TE Part # 184012-1 2 POS. PLUG ASSY, KEY G, GRAY</p>

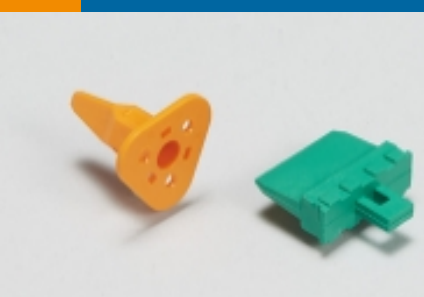
Also in the Series | **Sealed Sensor Connector SSC System**

 <p>Automotive Connector Caps & Covers (7)</p>	 <p>Automotive Connector Locks & Position Assurance(6)</p>	 <p>Automotive Housings(178)</p>	 <p>Automotive Seals & Cavity Plugs(3)</p>
---	---	---	---



Automotive Terminals(8)



Insertion & Extraction Tools(1)

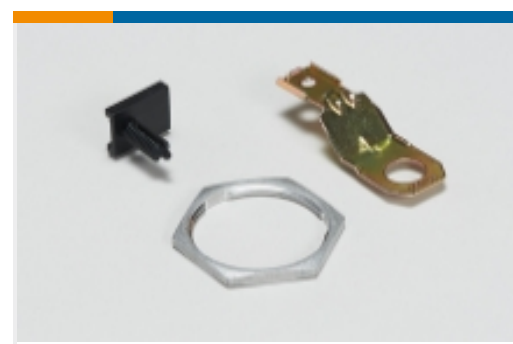

Other Automotive Connector Accessories(7)

Customers Also Bought

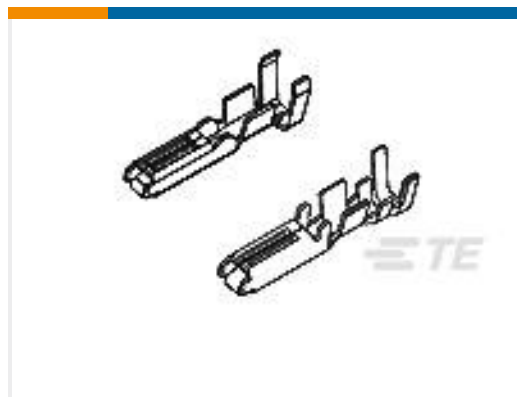
TE Part #776128-6
MULTILOCK, CONNECTOR HOUSINGTE Part #776129-2
.070 MULTILOCK RECEPTACLETE Part #184344-1
2X2 PLG ASY KEY A C3TE Part #184032-1
3 POS. PLUG ASSY, KEY ATE Part #2337311-1
2X2 PLG ASY KEY H C3 W/CPATE Part #1217486-1
FLUORESCENT TUBE SOCKET
TERMINALTE Part #2-2138685-5
27pos MQS .63 header 180degTE Part #2-2272352-5
20 POCKET CAN MODULE ASSY (KEY
B)TE Part #2337306-1
2X2 PLG ASY KEY G C3 W/CPA

Documents

Product Drawings

WIRE SEAL,RUBBER,SENSOR,ORANGE

English

CAD Files

3D PDF

English

Customer View Model

ENG_CVM_184140-1_B.2d_dxf.zip



English

Customer View Model

[ENG_CVM_184140-1_B.3d_igs.zip](#)

English

Customer View Model

[ENG_CVM_184140-1_B.3d_stp.zip](#)

English

By downloading the CAD file I accept and agree to the [Terms and Conditions](#) of use.

Product Specifications

[Application Specification](#)

English

Product Environmental Compliance

[MD_184140-1_02042018239_dmtec](#)

English

[MD_184140-1_02042018239_dmtec](#)

English