

1703013-1 ✓ ACTIVE

AMP | Round Connector System

TE Internal #: 1703013-1

Automotive Terminals, Pin, Pin Diameter .059 in [1.5 mm], 20 – 17 AWG Wire Size, .5 – 1 mm² Wire Size, Sealable, Round Connector System

[View on TE.com >](#)



Terminals & Splices > Automotive Terminals > ROUND CONNECTOR SYSTEM, PIN AND SOCKET

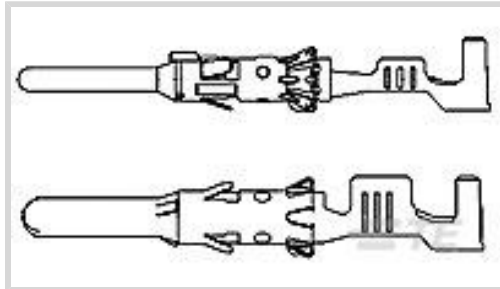

Terminal Type: Pin

Mating Pin Diameter: 1.5 mm [.059 in]

Terminal Transmits: 0 – 24 A (Low Power)

Wire Size: .5 – 1 mm²

[All Round Connector System, Pin and Socket \(74\)](#)

Features

Product Type Features

Receptacle Style	180°
Sealable	Yes
Primary Locking Feature	Locking Lance

Body Features

Terminal Seal Type	Single Wire Seal (SWS)
--------------------	------------------------

Contact Features

Typical Current Rating	20 A
Crimp Type	F-Crimp
Terminal Type	Pin
Mating Pin Diameter	1.5 mm [.059 in]
Interface Plating	Tin (Sn)

Termination Features

Termination Method to Wire & Cable	Crimp
Product Terminates To	Wire

Dimensions

Wire Size	.5 – 1 mm ²
Wire Size Search	17 AWG, 18 AWG, 19 AWG, 20 AWG



Wire Insulation Diameter	1.2 – 2.1 mm [.047 – .082 in]
--------------------------	-------------------------------

Usage Conditions

Insulation Option	Uninsulated
Operating Temperature (Max)	80 °C, 85 °C, 90 °C, 100 °C, 105 °C, 110 °C, 120 °C, 125 °C, 130 °C [176 °F][185 °F][194 °F][212 °F][221 °F][230 °F][248 °F][257 °F][266 °F]
Operating Temperature Range	-40 – 130 °C [-40 – 266 °F]

Operation/Application

Compatible With Wire Base Material	Copper
------------------------------------	--------

Packaging Features

Packaging Method	Reel
Packaging Quantity	3500

Other

Terminal Transmits	0 – 24 A (Low Power)
--------------------	----------------------

Product Compliance

[For compliance documentation, visit the product page on TE.com>](#)

EU RoHS Directive 2011/65/EU	Compliant
EU ELV Directive 2000/53/EC	Compliant
China RoHS 2 Directive MIIT Order No 32, 2016	No Restricted Materials Above Threshold
EU REACH Regulation (EC) No. 1907/2006	Current ECHA Candidate List: JAN 2022 (223) Candidate List Declared Against: JAN 2022 (223) Does not contain REACH SVHC
Halogen Content	Low Halogen - Br, Cl, F, I < 900 ppm per homogenous material. Also BFR/CFR/PVC Free
Solder Process Capability	Not applicable for solder process capability

Product Compliance Disclaimer

This information is provided based on reasonable inquiry of our suppliers and represents our current actual knowledge based on the information they provided. This information is subject to change. The part numbers that TE has identified as EU RoHS compliant have a maximum concentration of 0.1% by weight in homogenous materials for lead, hexavalent chromium, mercury, PBB, PBDE, DBP, BBP, DEHP, DIBP, and 0.01% for cadmium, or qualify for an exemption to these limits as defined in the Annexes of Directive 2011/65/EU (RoHS2). Finished electrical and electronic equipment products will be CE marked as required by Directive 2011/65/EU. Components may not be CE marked. Additionally, the part numbers that TE has identified as EU ELV compliant have a maximum concentration of 0.1% by weight in homogenous materials for lead, hexavalent chromium, and mercury, and 0.01% for cadmium, or qualify for an exemption to these limits

as defined in the Annexes of Directive 2000/53/EC (ELV). Regarding the REACH Regulation, the information TE provides on SVHC in articles for this part number is based on the latest European Chemicals Agency (ECHA) 'Guidance on requirements for substances in articles' posted at this URL: <https://echa.europa.eu/guidance-documents/guidance-on-reach>

Compatible Parts



TE Part # 3-1579007-7
EXTRACTION TOOL



TE Part # 58606-1
PROCIMP 1.5 & 2.5MM PIN/SEAL



TE Part # 2305570-1
TERMINAL CUTTER, SIDE FEED



TE Part # CAT-C4962-CH8172
CIRCULAR DIN HOUSINGS



TE Part # 828904-1
SINGLE WIRE SEAL FOR J.P.T.CON



TE Part # 1544676-1
1.5 MM PIN HSG 7W SEALED



TE Part # 2-2151139-1
OCEAN-2.0-APPLICATOR-S-080F160OV



TE Part # 2-2151139-2
OCEAN-2.0-APPLICATOR-S-080F160OV



TE Part # 2151139-1
OCEAN-2.0-APPLICATOR-S-080F160OV



TE Part # 2151139-2
OCEAN-2.0-APPLICATOR-S-080F160OV



TE Part # 5-2151139-1
OCEAN-2.0-APPLICATOR-S-080F160OV



TE Part # 5-2151139-2
OCEAN-2.0-APPLICATOR-S-080F160OV



TE Part # 58606-2
PC DIE 1.5 & 2.5 PIN W/S



TE Part # 7-2151139-1
OCEAN-2.0-APPLICATOR-S-080F160OV



TE Part # 7-2151139-2
OCEAN-2.0-APPLICATOR-S-080F160OV

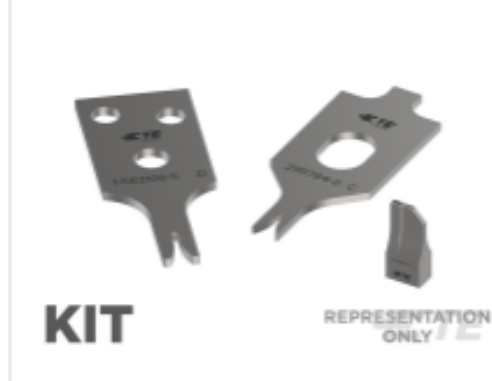

KIT
REPRESENTATION ONLY

TE Part # 7-2151139-7
OCEAN_2.0_SPARE_PART_KIT-080F160OV



Also in the Series | Round Connector System

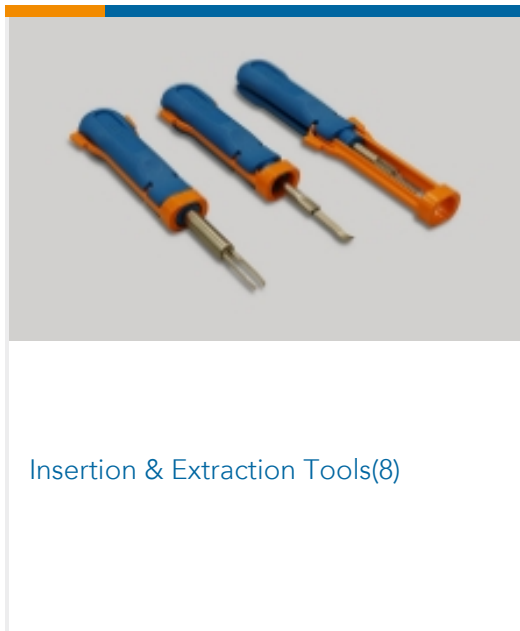
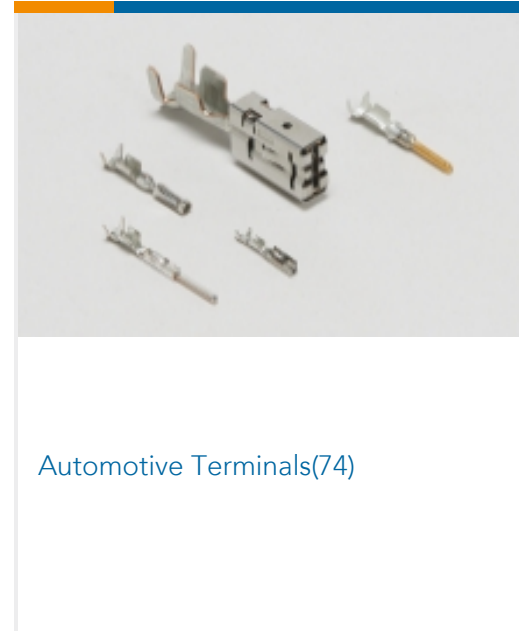
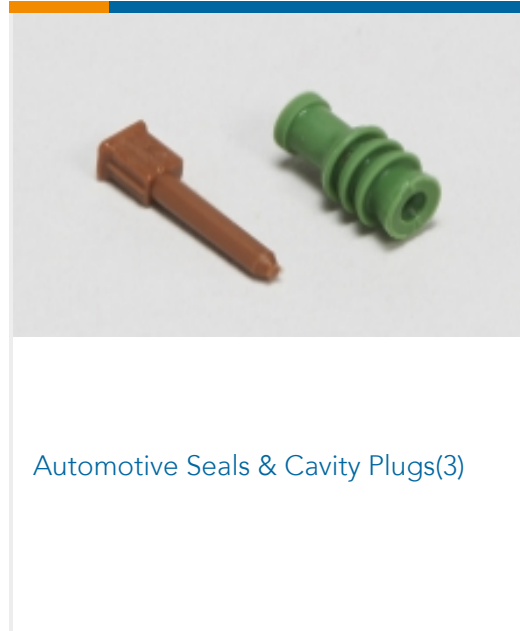
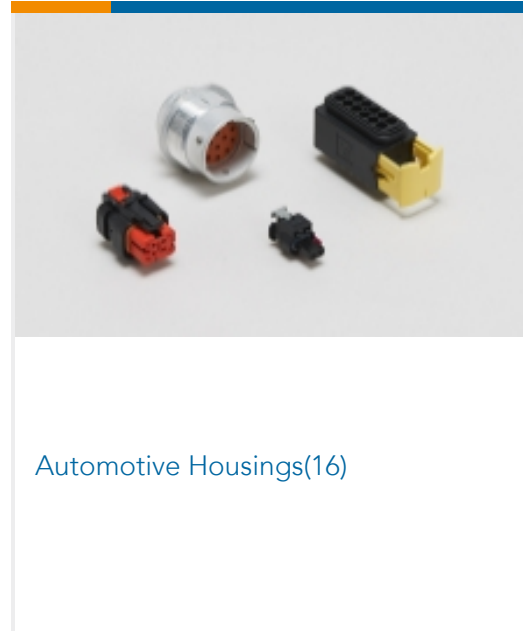
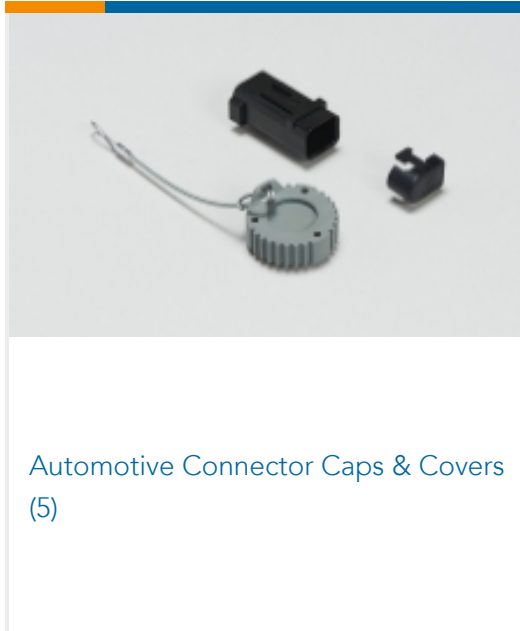

Customers Also Bought

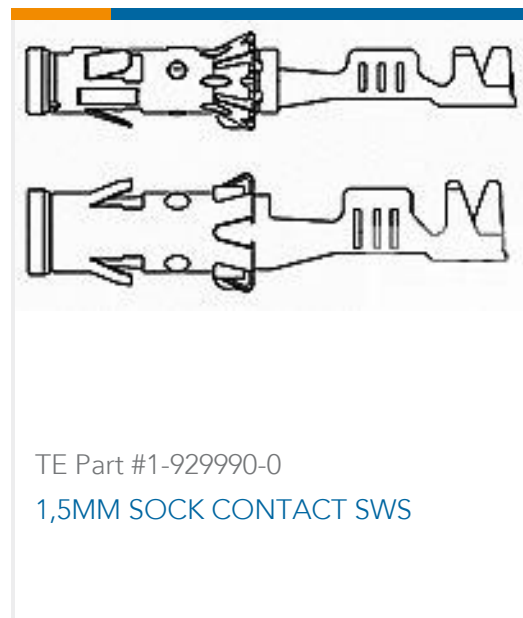

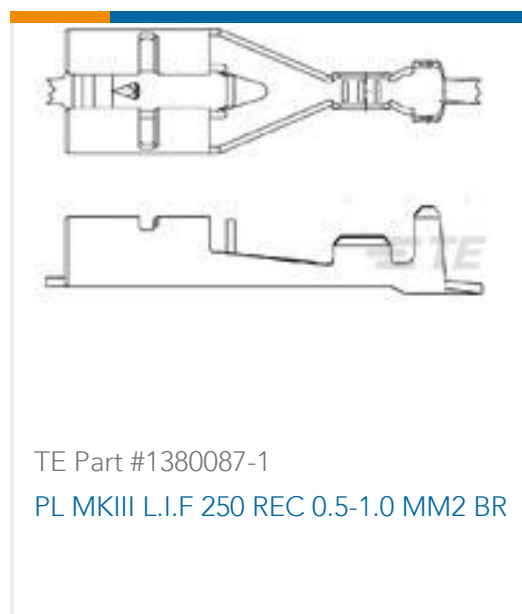

Documents

Product Drawings

[DIA 1.5MM CONTACT PIN,ASSY](#)

English

CAD Files

Customer View Model

[ENG_CVM_1703013-1_A3.3d_stp.zip](#)

English

Customer View Model

[ENG_CVM_1703013-1_A3.2d_dxf.zip](#)

English

Customer View Model

[ENG_CVM_1703013-1_A3.3d_igs.zip](#)

English

[3D PDF](#)

English

By downloading the CAD file I accept and agree to the [Terms and Conditions](#) of use.

Product Specifications

[Application Specification](#)

English

[Application Specification](#)

English

Product Environmental Compliance

[Product Compliance](#)

English

[Product Compliance](#)

English