

2-520181-2 ✓ ACTIVE

Ultra-Fast | Ultra-Fast 187

TE Internal #: 2-520181-2

Quick Disconnects, Receptacle, 22 – 18 AWG Wire Size, .32 – .82 mm<sup>2</sup> Wire Size, Mating Tab Width .187 in [4.75 mm], Straight, Brass, Ultra-Fast 187

[View on TE.com >](#)



Terminals & Splices > Quick Disconnects



Quick Disconnect Terminal Type: **Receptacle**

Wire Size: .32 – .82 mm<sup>2</sup>

Mating Tab Width: 4.75 mm [.187 in]

Mating Tab Thickness: .51 mm [.02 in]

## Features

### Product Type Features

Terminates To	Wire & Cable
Wire/Cable Type	Regular Wire
Wire Stop	Yes
Insertion Force	Normal
Sealable	No

### Configuration Features

Connection Capacity	Single
---------------------	--------

### Electrical Characteristics

Voltage (Max)	600 V
---------------	-------

### Body Features

Insulation Material	Nylon
---------------------	-------

### Contact Features

Quick Disconnect Terminal Type	Receptacle
Mating Tab Width	4.75 mm [.187 in]



Mating Tab Thickness	.51 mm[.02 in]
Terminal Orientation	Straight
Contact Base Material	Brass
Terminal Plating Material	Tin
Crimp Type	F-Crimp
Barrel Type	Closed

### Mechanical Attachment

Mating Retention Type	Dimple
Wire Insulation Support	With

### Dimensions

Accepts Wire Insulation Diameter Range	3.43 mm[.135 in]
Receptacle Terminal Stock Thickness	.41 mm[.016 in]
Overall Length	21.75 mm[.855 in]
Wire Size	.32 – .82 mm <sup>2</sup>

### Usage Conditions

Insulation Option	Uninsulated
Operating Temperature Range	-40 – 110 °C[-40 – 230 °F]

### Industry Standards

UL Flammability Rating	UL 94V-2
UL Rating	Listed

### Packaging Features

Packaging Quantity	2700
Packaging Method	Strip/Reel

### Other

Barrel Color	Red
--------------	-----

### Product Compliance

[For compliance documentation, visit the product page on TE.com>](#)

EU RoHS Directive 2011/65/EU	Compliant
EU ELV Directive 2000/53/EC	Compliant
China RoHS 2 Directive MIIT Order No 32, 2016	No Restricted Materials Above Threshold
EU REACH Regulation (EC) No. 1907/2006	



Current ECHA Candidate List: JAN 2022  
(223)  
Candidate List Declared Against: JAN 2022  
(223)  
Does not contain REACH SVHC

Halogen Content  
Low Halogen - Br, Cl, F, I < 900 ppm per homogenous material. Also BFR/CFR/PVC Free

Solder Process Capability  
Not applicable for solder process capability

Product Compliance Disclaimer

This information is provided based on reasonable inquiry of our suppliers and represents our current actual knowledge based on the information they provided. This information is subject to change. The part numbers that TE has identified as EU RoHS compliant have a maximum concentration of 0.1% by weight in homogenous materials for lead, hexavalent chromium, mercury, PBB, PBDE, DBP, BBP, DEHP, DIBP, and 0.01% for cadmium, or qualify for an exemption to these limits as defined in the Annexes of Directive 2011/65/EU (RoHS2). Finished electrical and electronic equipment products will be CE marked as required by Directive 2011/65/EU. Components may not be CE marked. Additionally, the part numbers that TE has identified as EU ELV compliant have a maximum concentration of 0.1% by weight in homogenous materials for lead, hexavalent chromium, and mercury, and 0.01% for cadmium, or qualify for an exemption to these limits as defined in the Annexes of Directive 2000/53/EC (ELV). Regarding the REACH Regulation, the information TE provides on SVHC in articles for this part number is based on the latest European Chemicals Agency (ECHA) 'Guidance on requirements for substances in articles' posted at this URL: <https://echa.europa.eu/guidance-documents/guidance-on-reach>

## Compatible Parts

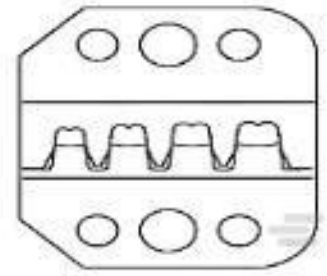

TE Part # 58628-2  
PROCIMP DIESET 26-14 ULTRAFAST



TE Part # 90390-3  
DIES ULTRA-FAST FASTON 22-18 DIE SET



TE Part # 58628-1  
PROCIMP T&D 26-14 ULTRAFAST



TE Part # 2151034-2  
OCEAN\_2.0\_APPLICATOR-S-1760



TE Part # 2-2151034-2  
OCEAN\_2.0\_APPLICATOR-S-1760



TE Part # 7-2151034-2  
OCEAN\_2.0\_APPLICATOR-S-1760



KIT  
REPRESENTATION ONLY

TE Part # 7-2151034-7  
OCEAN\_2.0\_SPARE\_PART\_KIT-1760

Also in the Series | **Ultra-Fast 187**



Quick Disconnects(47)

## Customers Also Bought



TE Part #62109-2  
250 FASTON REC 18-14 AWG TPBR

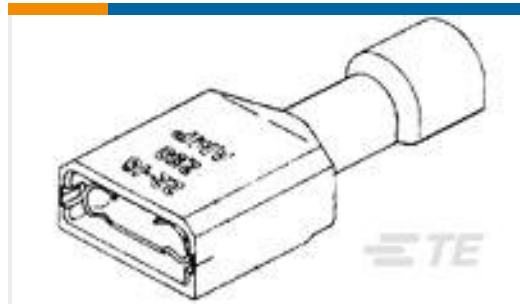

TE Part #3-520140-2  
ULTRA-FAST 250 ASY REC 16-14 AWG TPBR

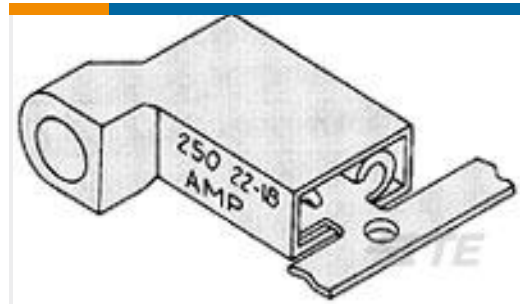

TE Part #2-520334-2  
ULTRAFAST 187 ASSY FLAG REC 22-18 TPBR

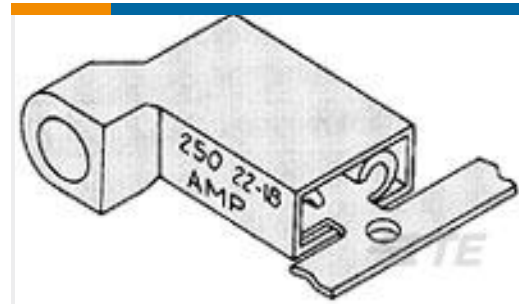

TE Part #3-520132-2  
ULTRAFAST 250 ASSY FLAG REC 16-14 TPBR



TE Part #2-520183-2  
ULTRA-FAST 250 ASY REC 22-18 TPBR

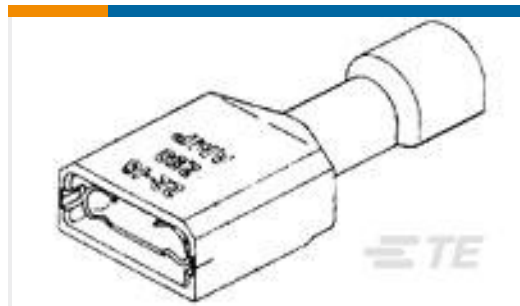

TE Part #2-520261-2  
ULTRA-FAST 187 ASY REC 22-18 TPBR



TE Part #2-520128-2  
ULTRA-FAST 250 ASY REC 22-18 AWG TPBR



TE Part #5256A  
STAINLESS STEEL CLIP

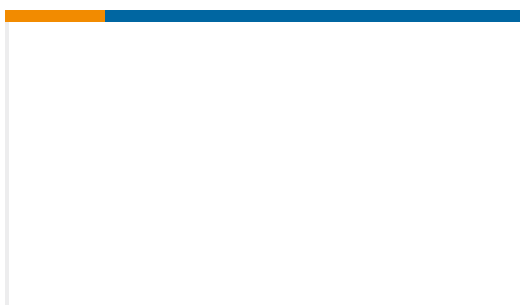

TE Part #A1004CS22P2  
CLIP-ON THERMISTOR ASSEMBLY

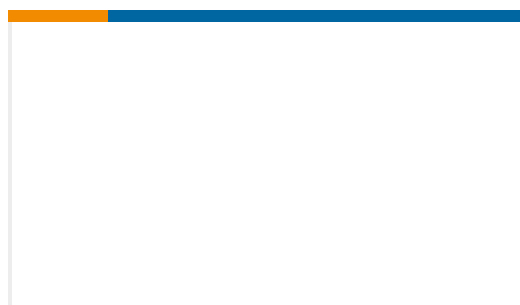

TE Part #D1004PX22P2-F  
NTC THERMISTOR ASSEMBLY

## Documents

### Product Drawings

[ULTRA-FAST 187 ASY REC 22-18 AWG TPBR](#)

English

### CAD Files

[3D PDF](#)

[3D](#)

### Customer View Model

[ENG\\_CVM\\_CVM\\_2-520181-2\\_AD\\_c-2-520181-2-ad.2d\\_dxf.zip](#)



English

**Customer View Model**

[ENG\\_CVM\\_CVM\\_2-520181-2\\_AD\\_c-2-520181-2-ad.3d\\_igs.zip](#)

English

**Customer View Model**

[ENG\\_CVM\\_CVM\\_2-520181-2\\_AD\\_c-2-520181-2-ad.3d\\_stp.zip](#)

English

By downloading the CAD file I accept and agree to the [Terms and Conditions](#) of use.

---

**Datasheets & Catalog Pages**

**Ultra-Fast and Ultra Fast Plus**

English

---

**Product Specifications**

**Application Specification**

English

**Application Specification**

English

---

**Product Environmental Compliance**

**MD\_2-520181-2\_022720182355\_dmtec**

English

**MD\_2-520181-2\_022720182355\_dmtec**

English

---

**Agency Approvals**

**Agency Approval Document**

English