

170456-1 ✓ ACTIVE

[Positive Lock](#) | [Positive Lock 250](#)

TE Internal #: 170456-1

Quick Disconnects, Receptacle, 12 – 10 AWG Wire Size, 3.31 – 5.26 mm² Wire Size, Mating Tab Width .25 in [6.35 mm], Straight, Brass, Positive Lock 250

[View on TE.com >](#)



Terminals & Splices > Quick Disconnects

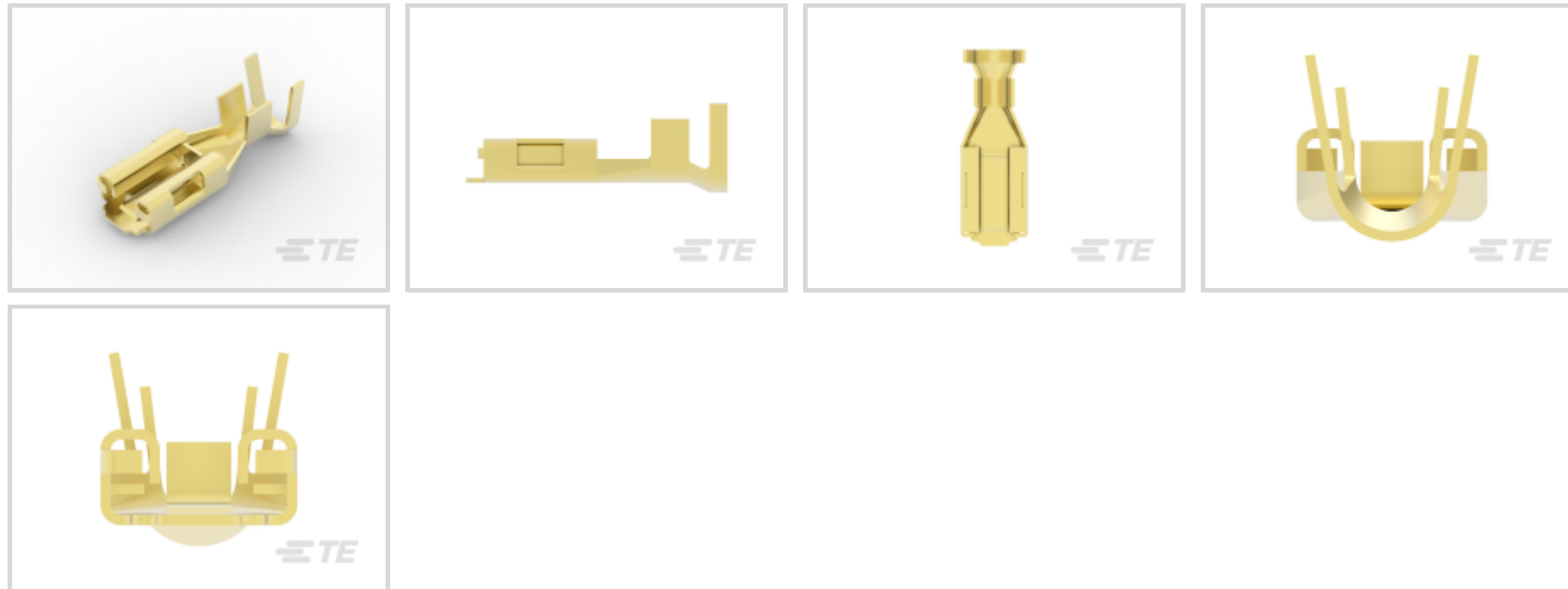

Quick Disconnect Terminal Type: **Receptacle**

Wire Size: **3.31 – 5.26 mm²**

Mating Tab Width: **6.35 mm [.25 in]**

Mating Tab Thickness: **.81 mm [.032 in]**

Features

Product Type Features

Terminates To	Wire & Cable
Wire/Cable Type	Regular Wire
Wire Stop	No
Insertion Force	Low
Sealable	No

Configuration Features

Connection Capacity	Single
---------------------	--------

Contact Features

Quick Disconnect Terminal Type	Receptacle
Mating Tab Width	6.35 mm[.25 in]
Mating Tab Thickness	.81 mm[.032 in]
Terminal Orientation	Straight
Contact Base Material	Brass
Terminal Plating Material	Unplated
Crimp Type	F-Crimp



Barrel Type	Open
-------------	------

Mechanical Attachment

Mating Retention Type	Dimple
Extraction Force	4.9 – 29.4 Newton
Wire Insulation Support	With

Dimensions

Accepts Wire Insulation Diameter Range	3.6 – 5 mm [.14 – .197 in]
Receptacle Terminal Stock Thickness	.41 mm [.016 in]
Overall Length	22.8 mm [.89 in]
Wire Size	3.31 – 5.26 mm ²

Usage Conditions

Insulation Option	Uninsulated
Operating Temperature Range	-40 – 110 °C [-40 – 230 °F]

Industry Standards

UL Rating	Listed
-----------	--------

Packaging Features

Packaging Quantity	3000
Packaging Method	Loose Piece/Carton

Other

Comment	Heavy Duty
---------	------------

Product Compliance

[For compliance documentation, visit the product page on TE.com>](#)

EU RoHS Directive 2011/65/EU	Compliant
EU ELV Directive 2000/53/EC	Compliant
China RoHS 2 Directive MIIT Order No 32, 2016	No Restricted Materials Above Threshold
EU REACH Regulation (EC) No. 1907/2006	Current ECHA Candidate List: JAN 2022 (223) Candidate List Declared Against: JAN 2022 (223) Does not contain REACH SVHC
Halogen Content	Low Halogen - Br, Cl, F, I < 900 ppm per homogenous material. Also BFR/CFR/PVC Free

Solder Process Capability

Not applicable for solder process capability

Product Compliance Disclaimer

This information is provided based on reasonable inquiry of our suppliers and represents our current actual knowledge based on the information they provided. This information is subject to change. The part numbers that TE has identified as EU RoHS compliant have a maximum concentration of 0.1% by weight in homogenous materials for lead, hexavalent chromium, mercury, PBB, PBDE, DBP, BBP, DEHP, DIBP, and 0.01% for cadmium, or qualify for an exemption to these limits as defined in the Annexes of Directive 2011/65/EU (RoHS2). Finished electrical and electronic equipment products will be CE marked as required by Directive 2011/65/EU. Components may not be CE marked. Additionally, the part numbers that TE has identified as EU ELV compliant have a maximum concentration of 0.1% by weight in homogenous materials for lead, hexavalent chromium, and mercury, and 0.01% for cadmium, or qualify for an exemption to these limits as defined in the Annexes of Directive 2000/53/EC (ELV). Regarding the REACH Regulation, the information TE provides on SVHC in articles for this part number is based on the latest European Chemicals Agency (ECHA) 'Guidance on requirements for substances in articles' posted at this URL: <https://echa.europa.eu/guidance-documents/guidance-on-reach>

Compatible Parts



TE Part # 172320-1
POSITIVE LOCK 250 (6.3 MM)
HOUSING



TE Part # 172863-2
POSITIVE LOCK (PL) .250 (6.3 MM)



TE Part # 172320-2
POSITIVE LOCK 250 (6.3 MM)
HOUSING



TE Part # 174090-2
PL .250 (6.3 MM) HOUSING



TE Part # 724659-2
EXT TOOL FOR POSITIVE .250



TE Part # 172864-2
250 HSG. REC. 6mm 2P BLACK



TE Part # 172434-2
POSITIVE LOCK 250 (6.3 MM)
HOUSING



TE Part # 174090-1
1P POSITIVE LOCK HSG



TE Part # 172320-3
POSITIVE LOCK 1P



TE Part # 172320-4
POSITIVE LOCK 1P GREEN



TE Part # 172433-2
250 AUTOMOTIVE POSITIVE LOCK 2P



TE Part # 172434-1
POSITIVE LOCK 250 (6.3 MM)
HOUSING



TE Part # 9-172320-2
POSIT LOCK HSG 1P BLACK VO94



TE Part # 1599720-1
PL 250 RECEPTACLE 0.2/0.5 MM2 BR



TE Part # 2-2150582-2
OCEAN_2.0_Applicator-S-150F250F



TE Part # 2150582-2
OCEAN_2.0_Applicator-S-150F250F



TE Part # 2219341-1
250 TAB CONT FOR GLASS ANT



TE Part # 7-2150582-2
OCEAN_2.0_Applicator-S-150F250F



TE Part # 7-2150582-7
OCEAN_2.0_SPARE_PART_KIT-150F250F

Also in the Series | Positive Lock 250

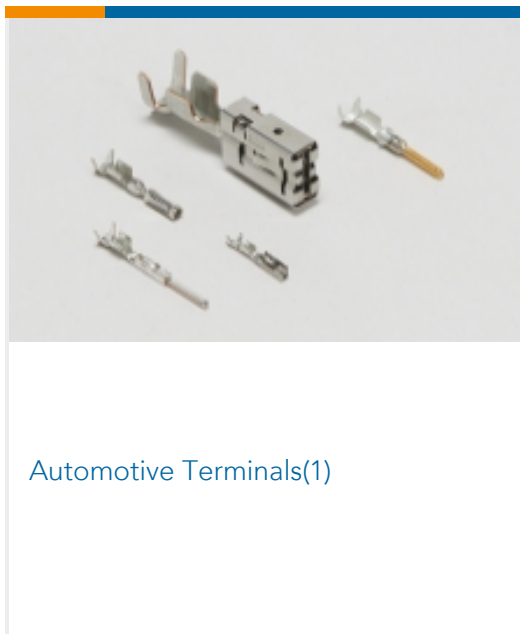

Automotive Terminals(1)

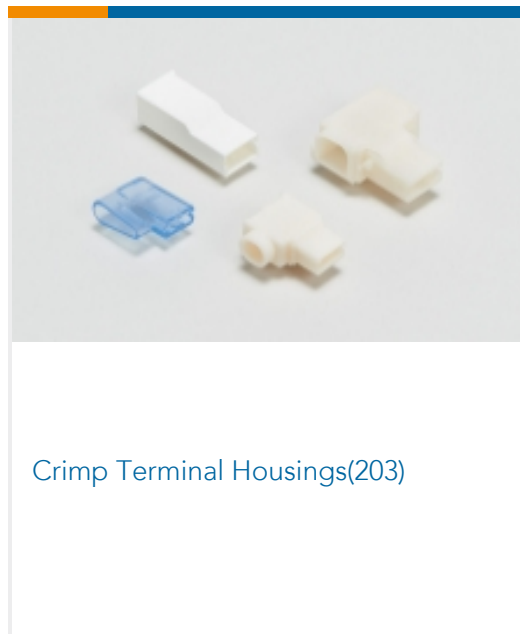

Crimp Terminal Housings(203)

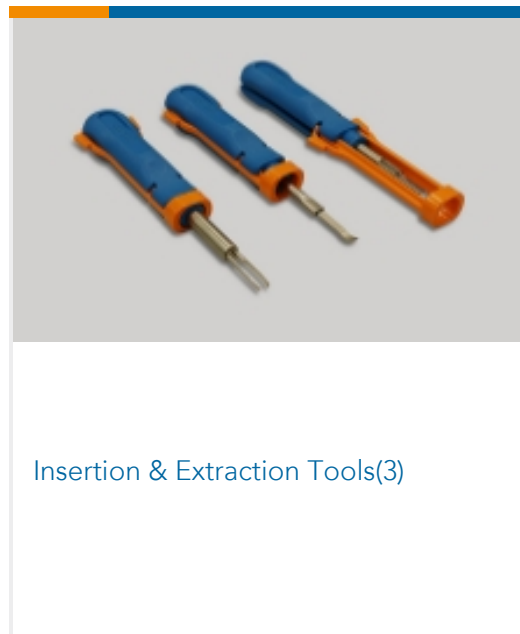

Insertion & Extraction Tools(3)



Insulation Boots & Sleeves(4)

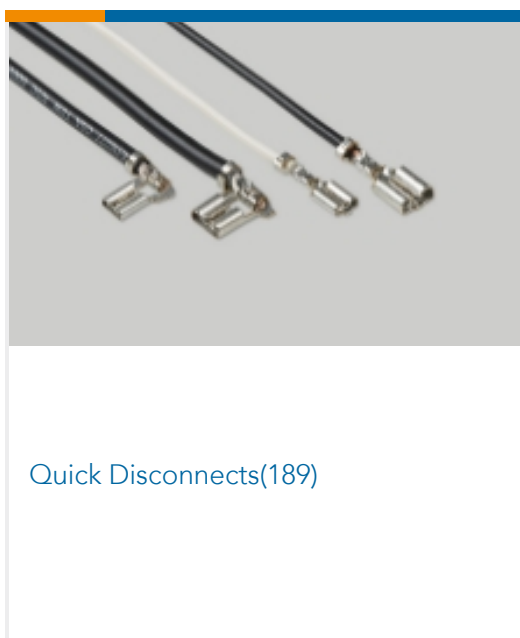

Quick Disconnects(189)

Customers Also Bought



TE Part #172320-2
POSITIVE LOCK 250 (6.3 MM)
HOUSING

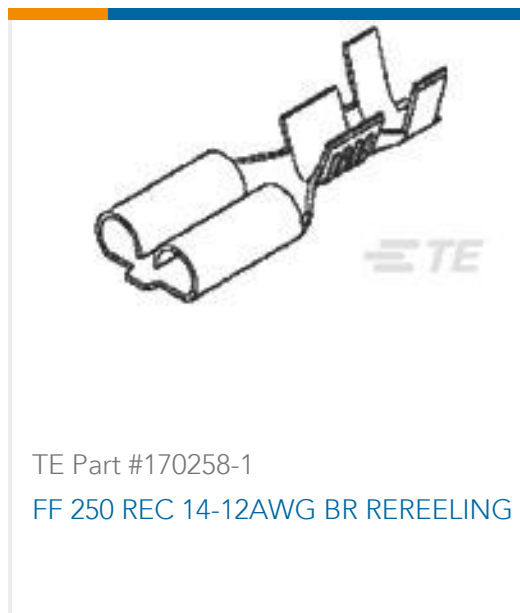

TE Part #170258-1
FF 250 REC 14-12AWG BR REREELING



TE Part #174090-2
PL .250 (6.3 MM) HOUSING



TE Part #316837-2
MULTILOCK, RECEPTACLE AND TAB

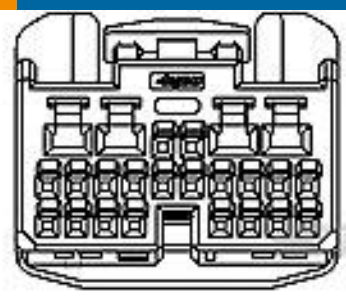

TE Part #1746864-2
0.64III/2.3II 24POS PLUG ASSY



TE Part #1952065-1
090 SERIES CONN 12 POS CAP HSG ASSY



TE Part #284715-1
32 POS AIRBAG CONN SHELL WITH



TE Part #1612122-1
SQUIB LOCKING BUTTON



TE Part #1612124-3
1DIA SOCKET AU

Documents

Product Drawings

[PL 250 AUTOMOTIVE REC 12-10 0.40 X 21 BR](#)

English

CAD Files

[3D PDF](#)

3D

Customer View Model

[ENG_CVM_CVM_170456-1_R.2d_dxf.zip](#)

English

Customer View Model

[ENG_CVM_CVM_170456-1_R.3d_igs.zip](#)

English

Customer View Model

[ENG_CVM_CVM_170456-1_R.3d_stp.zip](#)

English

By downloading the CAD file I accept and agree to the [Terms and Conditions](#) of use.

Product Specifications

[Crimping of Positive Lock Receptacle Contact](#)

English

[Application Specification](#)

English

[Crimping of 250 Series, Automotive Positive Lock Receptacle Contact](#)

English

[Application Specification](#)

English



Product Environmental Compliance

Product Compliance

English

Product Compliance

English

Instruction Sheets

Instruction Sheet (non U.S.)

English

Instruction Sheet (non U.S.)

Japanese