

2-521164-2 ✓ ACTIVE

Ultra-Fast | ULTRA-FAST 205

TE Internal #: 2-521164-2

Quick Disconnects, Receptacle, 22 – 18 AWG Wire Size, .32 – .82 mm² Wire Size, Mating Tab Width .205 in [5.21 mm], Flag, Brass, ULTRA-FAST 205

[View on TE.com >](#)



Terminals & Splices > Quick Disconnects

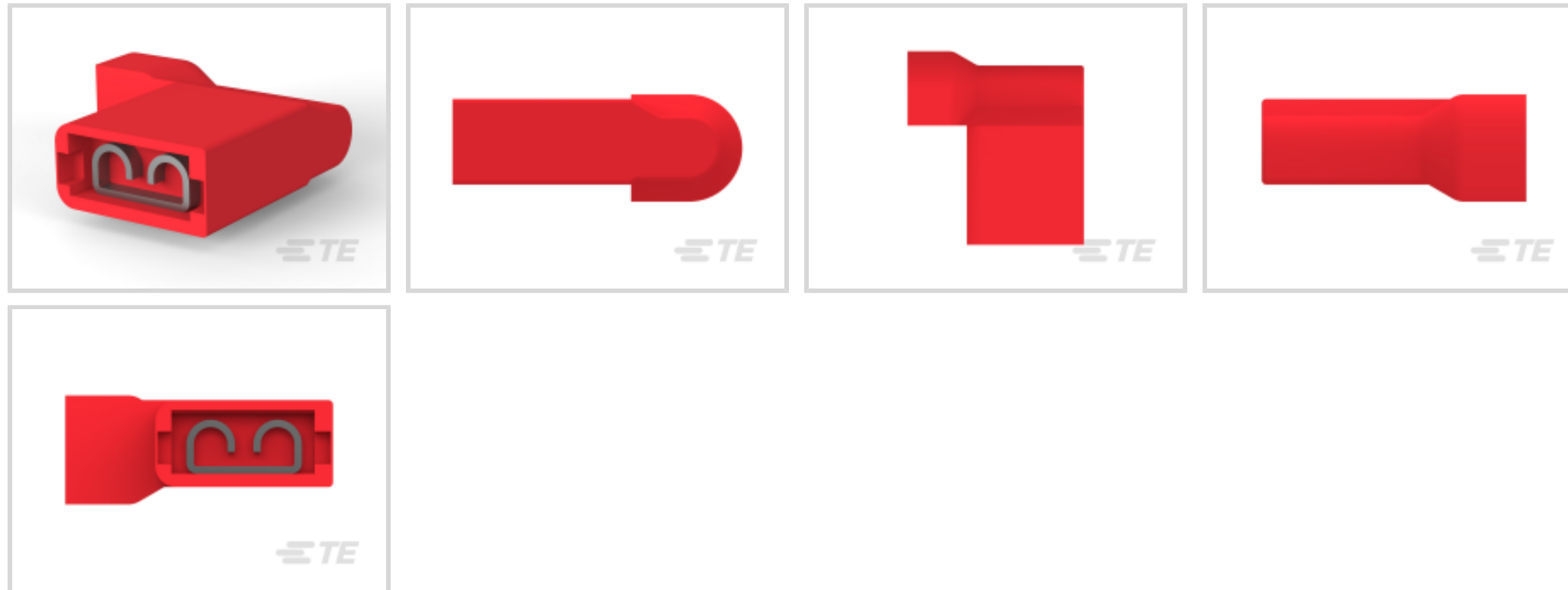

Quick Disconnect Terminal Type: **Receptacle**

Wire Size: .32 – .82 mm²

Mating Tab Width: 5.21 mm [.205 in]

Mating Tab Thickness: .81 mm [.032 in]

Features

Product Type Features

Terminates To	Wire & Cable
Wire/Cable Type	Discrete Wire
Wire Stop	No
Insertion Force	Low
Sealable	No

Configuration Features

Connection Capacity	Single
---------------------	--------

Electrical Characteristics

Voltage (Max)	600 V
---------------	-------

Body Features

Insulation Material	Nylon
---------------------	-------

Contact Features

Quick Disconnect Terminal Type	Receptacle
Mating Tab Width	5.21 mm [.205 in]



Mating Tab Thickness	.81 mm[.032 in]
Terminal Orientation	Flag
Contact Base Material	Brass
Terminal Plating Material	Tin
Crimp Type	F-Crimp
Barrel Type	Closed

Mechanical Attachment

Mating Retention Type	Dimple
Wire Insulation Support	With

Dimensions

Accepts Wire Insulation Diameter Range	4.19 mm[.165 in]
Receptacle Terminal Stock Thickness	.41 mm[.016 in]
Overall Length	14.73 mm[.58 in]
Wire Size	.32 – .82 mm ²

Usage Conditions

Insulation Option	Uninsulated
Operating Temperature Range	-40 – 110 °C[-40 – 230 °F]

Industry Standards

UL Flammability Rating	UL 94V-2
UL Rating	Listed

Packaging Features

Packaging Quantity	2200
Packaging Method	Strip/Reel

Other

Barrel Color	Red
--------------	-----

Product Compliance

[For compliance documentation, visit the product page on TE.com>](#)

EU RoHS Directive 2011/65/EU	Compliant
EU ELV Directive 2000/53/EC	Compliant
China RoHS 2 Directive MIIT Order No 32, 2016	No Restricted Materials Above Threshold
EU REACH Regulation (EC) No. 1907/2006	



Current ECHA Candidate List: JAN 2022
(223)
Candidate List Declared Against: JAN 2022
(223)
Does not contain REACH SVHC

Halogen Content
Low Halogen - Br, Cl, F, I < 900 ppm per homogenous material. Also BFR/CFR/PVC Free

Solder Process Capability
Not applicable for solder process capability

Product Compliance Disclaimer

This information is provided based on reasonable inquiry of our suppliers and represents our current actual knowledge based on the information they provided. This information is subject to change. The part numbers that TE has identified as EU RoHS compliant have a maximum concentration of 0.1% by weight in homogenous materials for lead, hexavalent chromium, mercury, PBB, PBDE, DBP, BBP, DEHP, DIBP, and 0.01% for cadmium, or qualify for an exemption to these limits as defined in the Annexes of Directive 2011/65/EU (RoHS2). Finished electrical and electronic equipment products will be CE marked as required by Directive 2011/65/EU. Components may not be CE marked. Additionally, the part numbers that TE has identified as EU ELV compliant have a maximum concentration of 0.1% by weight in homogenous materials for lead, hexavalent chromium, and mercury, and 0.01% for cadmium, or qualify for an exemption to these limits as defined in the Annexes of Directive 2000/53/EC (ELV). Regarding the REACH Regulation, the information TE provides on SVHC in articles for this part number is based on the latest European Chemicals Agency (ECHA) 'Guidance on requirements for substances in articles' posted at this URL: <https://echa.europa.eu/guidance-documents/guidance-on-reach>

Compatible Parts



TE Part # 90390-3
DIES ULTRA-FAST FASTON 22-18 DIE SET



TE Part # 2-2150252-2
OCEAN_2.0_APPLICATOR-E-201D



TE Part # 2150252-2
OCEAN_2.0_APPLICATOR-E-201D



TE Part # 7-2150252-2
OCEAN_2.0_APPLICATOR-E-201D



KIT
REPRESENTATION ONLY

TE Part # 7-2150252-7
OCEAN_2.0_SPARE_PART_KIT-201D

Also in the Series | **ULTRA-FAST 205**



Quick Disconnects(3)

Customers Also Bought

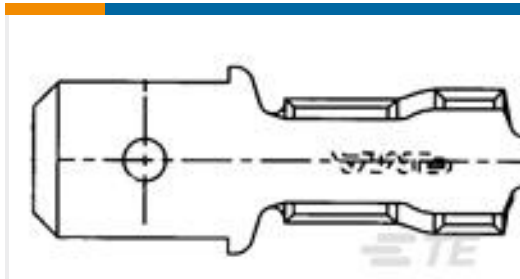

TE Part #41411
250 FASTON, TAB, 18-14 AWG, BR



TE Part #61352-1
RING .197 (5.0 MM) 10-6 AWG TPBR

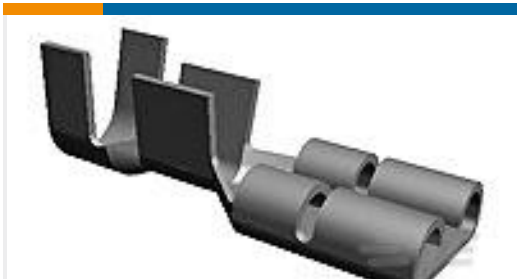

TE Part #63475-2
187 FASTON REC 20-16 AWG TPBR

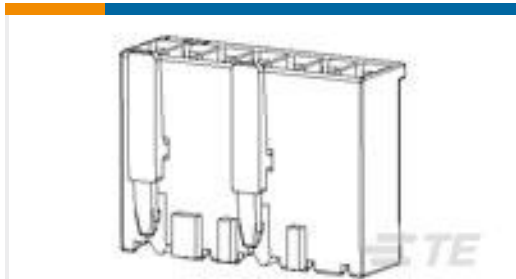

TE Part #928247-3
3P ST-TIMER GEH

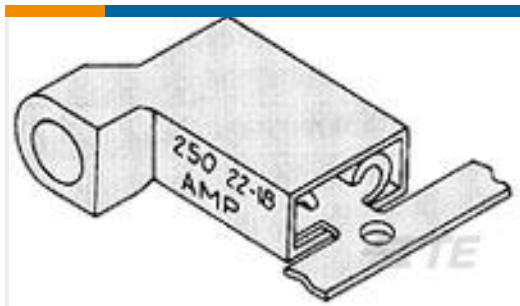

TE Part #9-520336-2
ULTRA-FAST 187 ASY REC 22-18 AWG TPBR

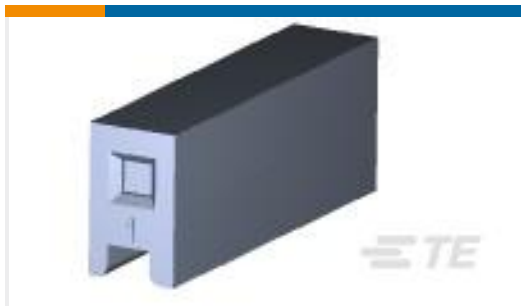

TE Part #640251-1
01P SL156 HSG W/O RAMP NATL



TE Part #521596-2
ULTRA-POD 187 ASSY REC 22-18 AWG TPBR



TE Part #2238136-2
RECEPTACLE, POSITIVE-LOCK, RAST 6.35

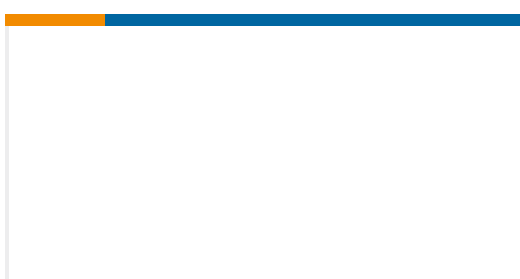

TE Part #2238212-2
RECEPTACLE, POSITIVE-LOCK, RAST 6.35

Documents

Product Drawings

[205 ULTRA-FAST ASY REC FLAG 22-18 TPBR](#)

English

CAD Files

Customer View Model

[ENG_CVM_CVM_2-521164-2_B.2d_dxf.zip](#)

English

[3D PDF](#)



3D

Customer View Model

[ENG_CVM_CVM_2-521164-2_B.3d_igs.zip](#)

English

Customer View Model

[ENG_CVM_CVM_2-521164-2_B.3d_stp.zip](#)

English

By downloading the CAD file I accept and agree to the [Terms and Conditions](#) of use.

Datasheets & Catalog Pages

[Ultra-Fast and Ultra Fast Plus](#)

English

Product Specifications

[Application Specification](#)

English

Product Environmental Compliance

[MD_2-521164-2_0420201538_dmtec](#)

English

[MD_2-521164-2_0420201538_dmtec](#)

English

Agency Approvals

[UL](#)

English