

170213-1 ✓ ACTIVE

FASTON | FASTON 250

TE Internal #: 170213-1

Quick Disconnects, Receptacle, 18 – 14 AWG Wire Size, .82 – 2.08 mm² Wire Size, Mating Tab Width .25 in [6.35 mm], Straight, Brass, FASTON 250

[View on TE.com >](#)



Terminals & Splices > Quick Disconnects

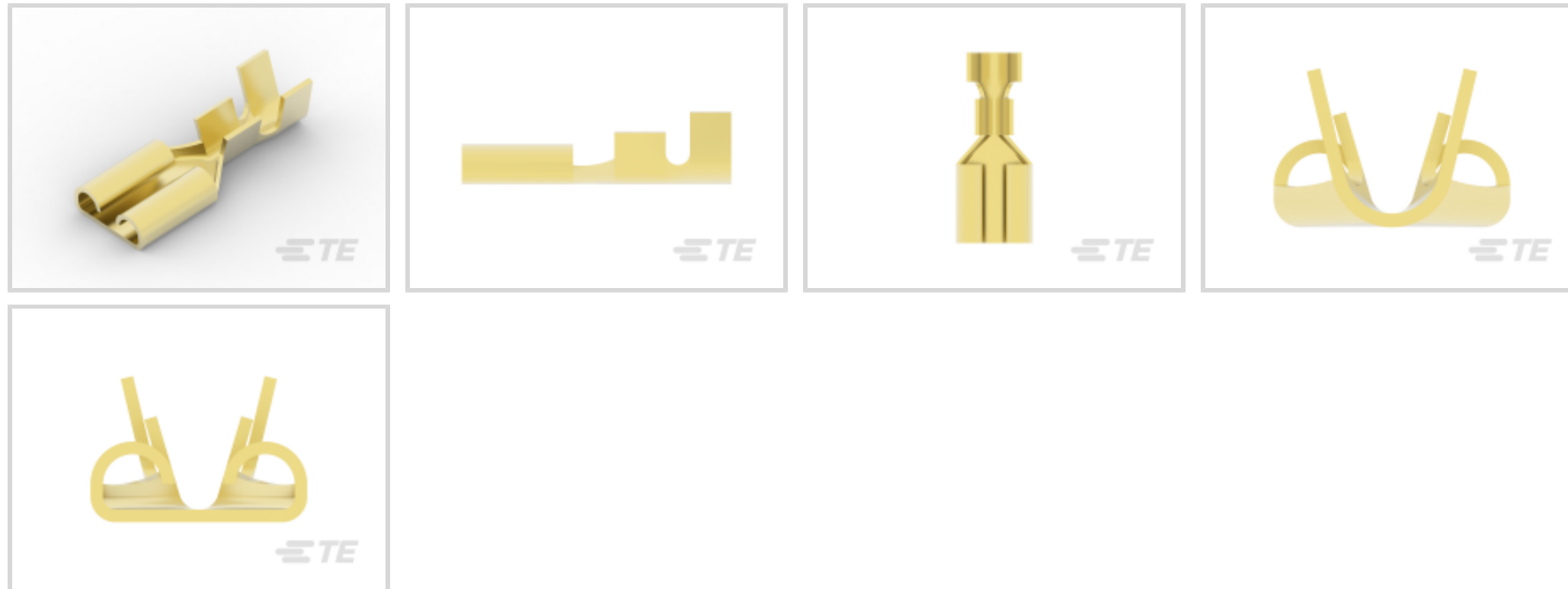

Quick Disconnect Terminal Type: **Receptacle**

Wire Size: **.82 – 2.08 mm²**

Mating Tab Width: **6.35 mm [.25 in]**

Mating Tab Thickness: **.81 mm [.032 in]**

Features

Product Type Features

Terminates To	Wire & Cable
Wire/Cable Type	Regular Wire
Wire Stop	No
Insertion Force	Normal
Sealable	No

Configuration Features

Connection Capacity	Single
---------------------	--------

Contact Features

Quick Disconnect Terminal Type	Receptacle
Mating Tab Width	6.35 mm[.25 in]
Mating Tab Thickness	.81 mm[.032 in]
Terminal Orientation	Straight
Contact Base Material	Brass
Terminal Plating Material	Unplated
Crimp Type	F-Crimp



Barrel Type	Open
-------------	------

Mechanical Attachment

Mating Retention Type	Dimple
Extraction Force	24.5 Newton
Wire Insulation Support	With

Dimensions

Accepts Wire Insulation Diameter Range	2.54 – 4.32 mm [.1 – .17 in]
Receptacle Terminal Stock Thickness	.43 mm [.017 in]
Overall Length	18.9 mm [.744 in]
Wire Size	.82 – 2.08 mm ²

Usage Conditions

Insulation Option	Uninsulated
Operating Temperature Range	-40 – 110 °C [-40 – 230 °F]

Industry Standards

CSA Certified	Yes
UL Rating	Listed

Packaging Features

Packaging Quantity	5000
Packaging Method	Strip/Reel

Other

Line	Budget
------	--------

Product Compliance

[For compliance documentation, visit the product page on TE.com>](#)

EU RoHS Directive 2011/65/EU	Compliant
EU ELV Directive 2000/53/EC	Compliant
China RoHS 2 Directive MIIT Order No 32, 2016	No Restricted Materials Above Threshold
EU REACH Regulation (EC) No. 1907/2006	Current ECHA Candidate List: JAN 2022 (223) Candidate List Declared Against: JAN 2022 (223) Does not contain REACH SVHC
Halogen Content	Low Halogen - Br, Cl, F, I < 900 ppm per homogenous material. Also BFR/CFR/PVC

Free

Solder Process Capability

Not applicable for solder process capability

Product Compliance Disclaimer

This information is provided based on reasonable inquiry of our suppliers and represents our current actual knowledge based on the information they provided. This information is subject to change. The part numbers that TE has identified as EU RoHS compliant have a maximum concentration of 0.1% by weight in homogenous materials for lead, hexavalent chromium, mercury, PBB, PBDE, DBP, BBP, DEHP, DIBP, and 0.01% for cadmium, or qualify for an exemption to these limits as defined in the Annexes of Directive 2011/65/EU (RoHS2). Finished electrical and electronic equipment products will be CE marked as required by Directive 2011/65/EU. Components may not be CE marked. Additionally, the part numbers that TE has identified as EU ELV compliant have a maximum concentration of 0.1% by weight in homogenous materials for lead, hexavalent chromium, and mercury, and 0.01% for cadmium, or qualify for an exemption to these limits as defined in the Annexes of Directive 2000/53/EC (ELV). Regarding the REACH Regulation, the information TE provides on SVHC in articles for this part number is based on the latest European Chemicals Agency (ECHA) 'Guidance on requirements for substances in articles' posted at this URL: <https://echa.europa.eu/guidance-documents/guidance-on-reach>

Compatible Parts



TE Part # 2232112-1
250 FASTON,REC.,18-14 AWG,TPBR



TE Part # 2232247-1
250 FASTON,REC.,16-10 AWG,BR



TE Part # 755336-1
DAHT FASTON 22-14 ASSY



TE Part # 735211-2
250 FASTON REC 14-10 AWG TPBR



TE Part # 2-2150060-1
OC-PA-E-FM-110F180F-001-0056



TE Part # 2-2150060-2
OC-PA-E-FA-110F180F-001-0056



TE Part # 2-2150062-2
OCEAN_2.0_Applicator-E-150F220F



TE Part # 2150060-1
OC-AT-E-FM-110F180F-001-0056



TE Part # 2150060-2
OC-AT-E-FA-110F180F-001-0056



TE Part # 7-2150060-7
OC-110F180F-CRIMPTOOLINGKIT

Also in the Series | **FASTON 250**



Compression Connectors(4)

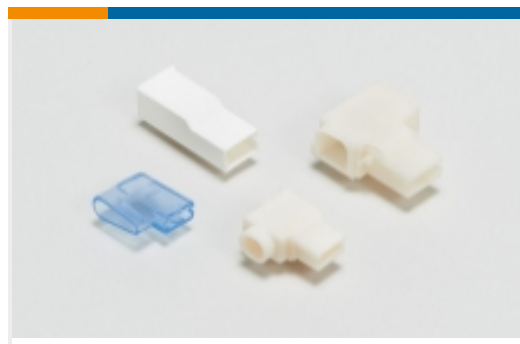

Crimp Terminal Housings(143)

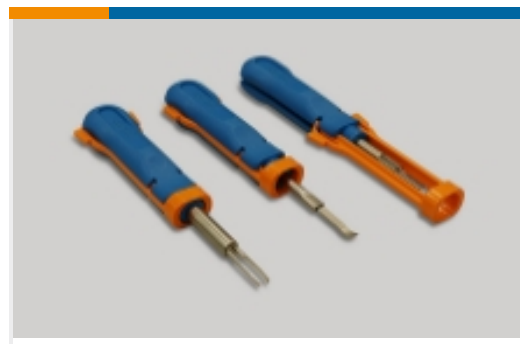

Insertion & Extraction Tools(6)



Magnet Wire Terminals(1)



PCB Terminals(144)



Quick Disconnects(456)



Splices(4)

Customers Also Bought



TE Part #2-1971905-3
PLUG HOUSING 6POS,KEYING-B,
NEW GIC3.3

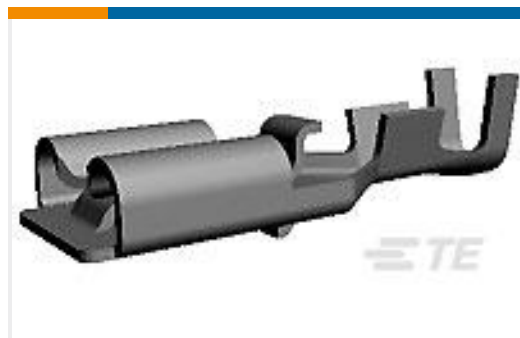

TE Part #179973-1
250 PL EX REC. 22-18AWG PTBR



TE Part #1376392-2
STD Temp Power Key Plug



TE Part #179973-6
PL EX 250 REC 22-18 PTPCOPPER-
ALLOY

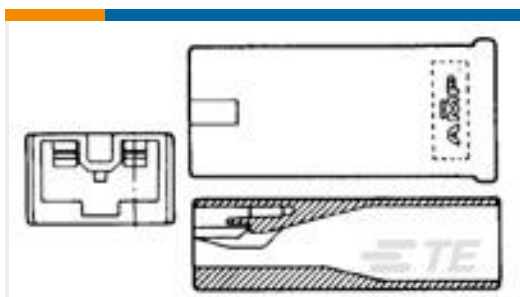

TE Part #179970-2
PL EXII 250 REC HSG 1P NYLON RED

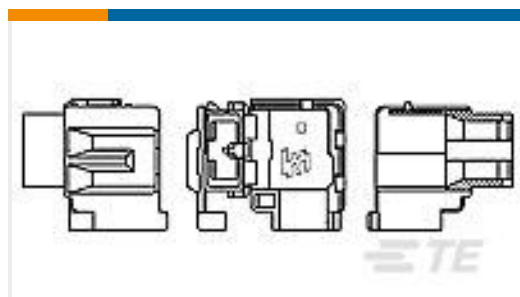

TE Part #2013799-1
250 HSG. PL EX REC. BLACK

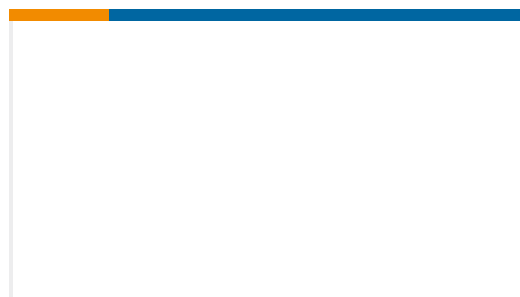

TE Part #1-1376388-3
5.0 PK CONN. 2P PLUG HSG (W/O
GF) - RED

Documents

Product Drawings

250 FASTON,REC.,18-14 AWG,BR

English

CAD Files

3D PDF

3D

Customer View Model

ENG_CVM_CVM_170213-1_T.2d_dxf.zip



English

Customer View Model

[ENG_CVM_CVM_170213-1_T.3d_igs.zip](#)

English

Customer View Model

[ENG_CVM_CVM_170213-1_T.3d_stp.zip](#)

English

By downloading the CAD file I accept and agree to the [Terms and Conditions](#) of use.

Product Specifications

[Application Specification](#)

English

Product Environmental Compliance

[MD_170213-1_05312018108_dmtec](#)

English

[MD_170213-1_05312018108_dmtec](#)

English