



Generation Y Connector System

TE Internal #: 1924968-3

Automotive Terminals, Tab, Mating Tab Width .8 mm [.031 in], Tab Thickness .025 in [.64 mm], 22 – 20 AWG Wire Size, Generation Y Connector System

[View on TE.com >](#)

Terminals & Splices > Automotive Terminals > Generation Y Terminals, 68POS Hybrid

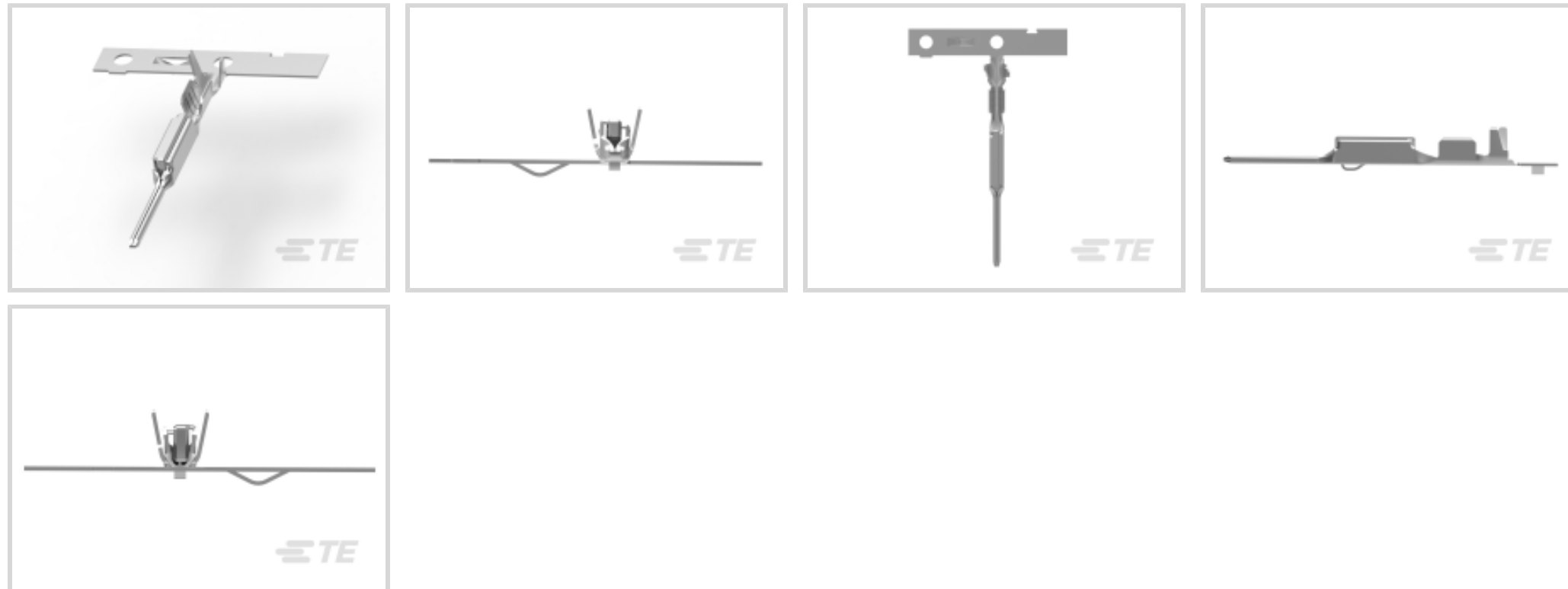

Terminal Type: **Tab**

Mating Tab Width: **.8 mm [ .031 in ]**

Mating Tab Thickness: **.64 mm [ .025 in ]**

Terminal Transmits: **0 – 24 A (Low Power)**

Wire Size: **22 – 20 AWG**

[All Generation Y Terminals, 68POS Hybrid \(10\)](#)

**Features**

**Product Type Features**

Sealable	Yes
Primary Locking Feature	Clean Body

**Body Features**

Terminal Seal Type	Family Seal
--------------------	-------------

**Contact Features**

Typical Current Rating	9 A
Crimp Type	F-Crimp
Terminal Type	Tab
Mating Tab Width	.8 mm[.031 in]
Mating Tab Thickness	.64 mm[.025 in]
Interface Plating	Tin (Sn)
Contact Termination Area Plating Material	Tin (Sn)



### Termination Features

Termination Method to Wire & Cable	Crimp
Product Terminates To	Wire

### Dimensions

Wire Size	.35 – .5 mm <sup>2</sup>
Wire Size Search	20 AWG, 21 AWG, 22 AWG
Wire Insulation Diameter	1.5 – 1.85 mm [.059 – .073 in]

### Usage Conditions

Insulation Option	Uninsulated
Operating Temperature (Max)	80 °C, 85 °C, 90 °C, 100 °C [176 °F][185 °F] [194 °F][212 °F]
Operating Temperature Range	-40 – 100 °C [-40 – 212 °F]

### Operation/Application

Compatible With Wire Base Material	Copper
------------------------------------	--------

### Industry Standards

Agency/Standard	SAE/USCAR-2, USCAR-21
-----------------	-----------------------

### Packaging Features

Packaging Method	Package
Packaging Quantity	7500

### Other

Terminal Transmits	0 – 24 A (Low Power)
--------------------	----------------------

### Product Compliance

[For compliance documentation, visit the product page on TE.com>](#)

EU RoHS Directive 2011/65/EU	Compliant
EU ELV Directive 2000/53/EC	Compliant
China RoHS 2 Directive MIIT Order No 32, 2016	No Restricted Materials Above Threshold
EU REACH Regulation (EC) No. 1907/2006	Current ECHA Candidate List: JAN 2022 (223) Candidate List Declared Against: JAN 2022 (223) Does not contain REACH SVHC
Halogen Content	Low Halogen - Br, Cl, F, I < 900 ppm per homogenous material. Also BFR/CFR/PVC

Free

Solder Process Capability

Not applicable for solder process capability

Product Compliance Disclaimer

This information is provided based on reasonable inquiry of our suppliers and represents our current actual knowledge based on the information they provided. This information is subject to change. The part numbers that TE has identified as EU RoHS compliant have a maximum concentration of 0.1% by weight in homogenous materials for lead, hexavalent chromium, mercury, PBB, PBDE, DBP, BBP, DEHP, DIBP, and 0.01% for cadmium, or qualify for an exemption to these limits as defined in the Annexes of Directive 2011/65/EU (RoHS2). Finished electrical and electronic equipment products will be CE marked as required by Directive 2011/65/EU. Components may not be CE marked. Additionally, the part numbers that TE has identified as EU ELV compliant have a maximum concentration of 0.1% by weight in homogenous materials for lead, hexavalent chromium, and mercury, and 0.01% for cadmium, or qualify for an exemption to these limits as defined in the Annexes of Directive 2000/53/EC (ELV). Regarding the REACH Regulation, the information TE provides on SVHC in articles for this part number is based on the latest European Chemicals Agency (ECHA) 'Guidance on requirements for substances in articles' posted at this URL: <https://echa.europa.eu/guidance-documents/guidance-on-reach>

## Compatible Parts



TE Part # 2138558-1  
2P GENERATION Y Cap, Single-Pi



TE Part # 2305570-1  
TERMINAL CUTTER, SIDE FEED



TE Part # CAT-N58-ATHA68  
68POS, HYBRID, REC and TAB HSG ASSY



TE Part # 2151725-1  
OCEAN\_2.0\_APPLICATOR-S-053F061O



**KIT**  
REPRESENTATION ONLY

TE Part # 7-2151725-7  
OCEAN\_2.0\_SPARE\_PART\_KIT-053F061O



TE Part # 2138558-2  
2P GENERATION Y Cap, Single-Pi



TE Part # 2138558-3  
2P G-Y Cap, Single-Piece, No Clip, A



TE Part # 2063291-1  
PRO-C HT & DIE GEN Y



TE Part # 2203535-1  
1X4 GENERATION Y WITH GET INTERFACE



TE Part # 2-2151725-1  
OCEAN\_2.0\_APPLICATOR-S-053F061O



TE Part # 2-2151725-2  
OCEAN\_2.0\_APPLICATOR-S-053F061O



TE Part # 2-2208018-1  
22POS, 0.64 MALE GEN. Y, PIN HSG, ASSY



TE Part # 2035306-1  
Insert, Jack, Gen Y, Hybrid, FAKRA 4



TE Part # 2098165-1  
CONTACT,FEMALE, 0.64, 20-22, C



TE Part # 2151725-2  
OCEAN\_2.0\_APPPLICATOR-S-053F061O



TE Part # 2203535-2  
1X4 GENERATION Y WITH GET INTERFACE



TE Part # 2203535-3  
1X4 GENERATION Y WITH GET INTERFACE



TE Part # 2203535-4  
1X4 GENERATION Y WITH GET INTERFACE



TE Part # 2295167-1  
22POS,0.64 MALE GEN. Y,TABHSG, ASSY,SLD



TE Part # 7-2151725-1  
OCEAN\_2.0\_APPPLICATOR-S-053F061O

## Also in the Series | Generation Y Connector System



Automotive Connector Caps & Covers (16)



Automotive Housings(153)



Automotive Terminals(39)



Insertion & Extraction Tools(1)



PCB Headers & Receptacles(15)

## Customers Also Bought



TE Part #936271-1  
090III 6P(D) CAP ASSY



TE Part #1438299-2  
GET MALE TERM, A, SN



TE Part #1745068-1  
3 POS. MCP 1,5 SRS. REC. CONNECTOR UNSLD.



TE Part #926820-1  
PL 250 REC TERMINAL-FLAG 20-15 PTPPB

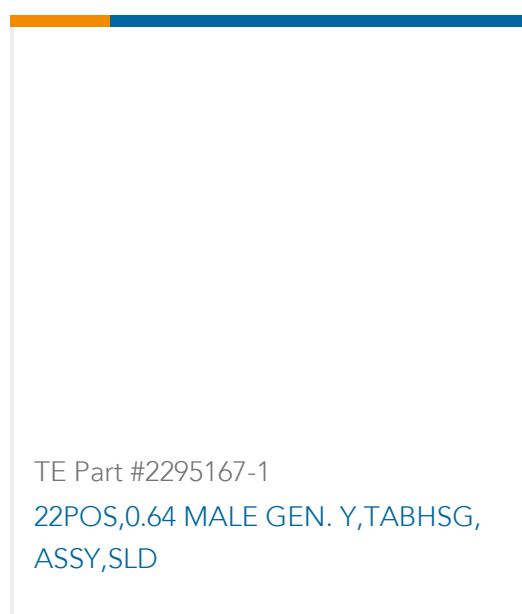

## Documents

### Product Drawings

[Contact, male 0.64, 20 to 22 AWG](#)

English

### CAD Files

Customer View Model

[ENG\\_CVM\\_CVM\\_1924968-3\\_B.2d\\_dxf.zip](#)

English

[3D PDF](#)

3D

Customer View Model

[ENG\\_CVM\\_CVM\\_1924968-3\\_B.3d\\_igs.zip](#)

English

Customer View Model

[ENG\\_CVM\\_CVM\\_1924968-3\\_B.3d\\_stp.zip](#)

English

By downloading the CAD file I accept and agree to the [Terms and Conditions](#) of use.

### Product Specifications

[Application Specification](#)

English

### Product Environmental Compliance

[Product Compliance](#)

English

[Product Compliance](#)

English

1924968-3

Automotive Terminals, Tab, Mating Tab Width .8 mm [.031 in], Tab Thickness .025 in [.64 mm], 22 – 20 AWG Wire Size, Generation Y Connector System

