

175090-1 ✓ ACTIVE

AMP | Econoseal

TE Internal #: 175090-1

Automotive Terminals, Receptacle, Mating Tab Width 4.8 mm [.189 in], Tab Thickness .031 in [.8 mm], 20 – 16 AWG Wire Size, Econoseal

[View on TE.com >](#)



Terminals & Splices > Automotive Terminals > Econoseal Receptacles and Tabs



Terminal Type: **Receptacle**

Mating Tab Width: **4.8 mm [.189 in]**

Mating Tab Thickness: **.8 mm [.031 in]**

Terminal Transmits: **0 – 24 A (Low Power)**

Wire Size: **20 – 16 AWG**

[All Econoseal Receptacles and Tabs \(45\)](#)

Features

Product Type Features

Receptacle Style	180°
Sealable	Yes
Primary Locking Feature	Clean Body

Body Features

Terminal Seal Type	Single Wire Seal (SWS)
--------------------	------------------------

Contact Features

Typical Current Rating	14 A
Crimp Type	F-Crimp
Terminal Type	Receptacle
Mating Tab Width	4.8 mm [.189 in]
Mating Tab Thickness	.8 mm [.031 in]
Interface Plating	Tin (Sn)
Contact Termination Area Plating Material	Tin (Sn)

Termination Features

Termination Method to Wire & Cable	Crimp
Product Terminates To	Wire

Dimensions



Wire Size	.5 – 1.25 mm ²
Wire Size Search	16 AWG, 17 AWG, 18 AWG, 19 AWG, 20 AWG
Wire Insulation Diameter	2 – 2.7 mm [.078 – .102 in]

Usage Conditions

Insulation Option	Uninsulated
Operating Temperature (Max)	80 °C, 85 °C, 90 °C, 100 °C, 105 °C [176 °F] [185 °F] [194 °F] [212 °F] [221 °F]
Operating Temperature Range	-30 – 105 °C [-22 – 221 °F]

Operation/Application

Compatible With Wire Base Material	Copper
------------------------------------	--------

Packaging Features

Packaging Method	Reel
Packaging Quantity	3000

Other

Terminal Transmits	0 – 24 A (Low Power)
--------------------	----------------------

Product Compliance

[For compliance documentation, visit the product page on TE.com>](#)

EU RoHS Directive 2011/65/EU	Compliant
EU ELV Directive 2000/53/EC	Compliant
China RoHS 2 Directive MIIT Order No 32, 2016	No Restricted Materials Above Threshold
EU REACH Regulation (EC) No. 1907/2006	Current ECHA Candidate List: JAN 2022 (223) Candidate List Declared Against: JAN 2022 (223) Does not contain REACH SVHC
Halogen Content	Low Halogen - Br, Cl, F, I < 900 ppm per homogenous material. Also BFR/CFR/PVC Free
Solder Process Capability	Not applicable for solder process capability

Product Compliance Disclaimer

This information is provided based on reasonable inquiry of our suppliers and represents our current actual knowledge based on the information they provided. This information is subject to change. The part numbers that TE has identified as EU RoHS compliant have a maximum concentration of 0.1% by weight in homogenous materials for lead, hexavalent chromium, mercury, PBB, PBDE, DBP, BBP, DEHP, DIBP, and 0.01% for cadmium, or qualify for an exemption to these limits as defined in the Annexes of Directive 2011/65/EU (RoHS2). Finished electrical and electronic equipment products

will be CE marked as required by Directive 2011/65/EU. Components may not be CE marked. Additionally, the part numbers that TE has identified as EU ELV compliant have a maximum concentration of 0.1% by weight in homogenous materials for lead, hexavalent chromium, and mercury, and 0.01% for cadmium, or qualify for an exemption to these limits as defined in the Annexes of Directive 2000/53/EC (ELV). Regarding the REACH Regulation, the information TE provides on SVHC in articles for this part number is based on the latest European Chemicals Agency (ECHA) 'Guidance on requirements for substances in articles' posted at this URL: <https://echa.europa.eu/guidance-documents/guidance-on-reach>

Compatible Parts



TE Part # CAT-EC7491-CH8172
ECONOSEAL, CONNECTOR HOUSING



TE Part # 85024-1
RUBBER PLUG GRAY FOR 187 SEALD



TE Part # 2-2837276-1
OCEAN_2.0_Applicator-S-100F1900



TE Part # 2-2837276-2
OCEAN_2.0_SPARE_PART_KIT-100F1900



TE Part # 2837276-1
OCEAN_2.0_Applicator-S-100F1900



TE Part # 2837276-2
OCEAN_2.0_Applicator-S-100F1900



TE Part # 368482-2
ABS CONN PLUG 25P ASSY



TE Part # 368482-3
ABS CONN PLUG 25P ASSY



TE Part # 368482-4
ABS CONN PLUG 25P ASSY

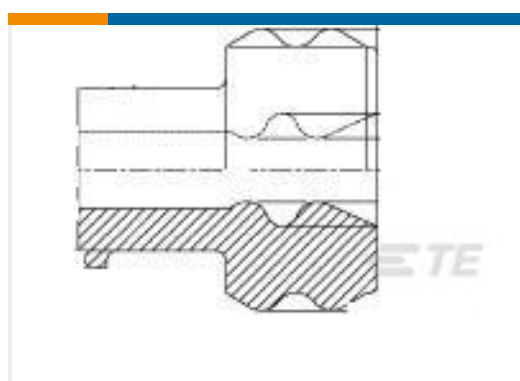

TE Part # 368941-1
WIRE SEAL FOR ABS 25P(2.4-3.2)



TE Part # 7-2837276-1
OCEAN_2.0_Applicator-S-100F1900



TE Part # 7-2837276-2
OCEAN_2.0_Applicator-S-100F1900

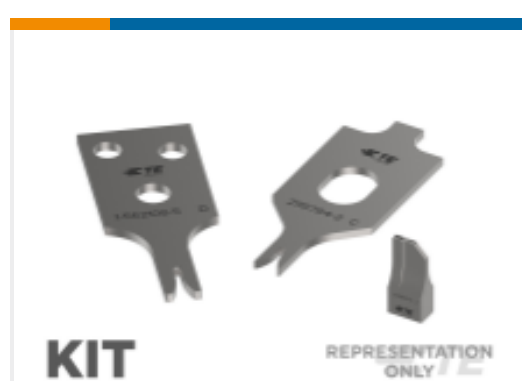

TE Part # 7-2837276-7
OC-100F1900-CRIMPTOOLINGKIT

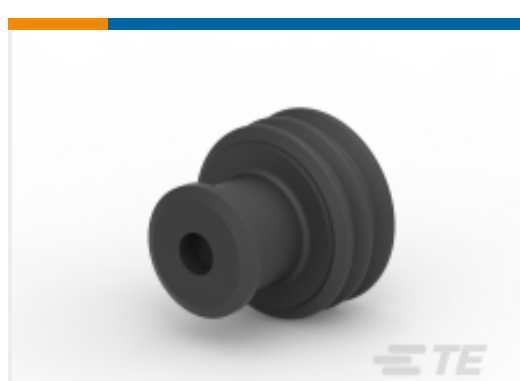

TE Part # 936945-1
WIRE SEAL FOR ABS 25P(2.4-3.2)



TE Part # 1717471-1
060/187 ABS 26POS PLUG ASSY

Also in the Series | Econoseal



Automotive Connector Caps & Covers (1)



Automotive Connector Locks & Position Assurance(25)



Automotive Housings(62)



Automotive Seals & Cavity Plugs(17)



Automotive Terminals(47)



Insertion & Extraction Tools(7)



Other Automotive Connector Accessories(5)

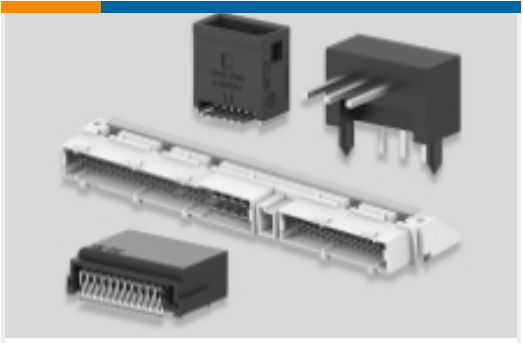

PCB Headers & Receptacles(4)

Customers Also Bought



TE Part #1924393-1
MCON, CONNECTOR HOUSING



TE Part #964282-2
JPT A REC 2.8 Contact SWS Sn



TE Part #368049-1
E-J MK-II(+) 16P PLUG DBL



TE Part #184311-1
ASSY, PLUG HSG 3 POS, KEY A

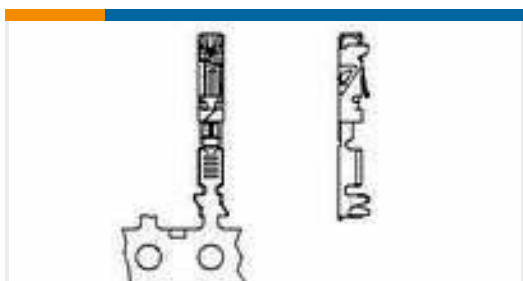

TE Part #1-1411552-1
ELOSTD M5300Y55



TE Part #184408-1
2X2 CAP ASSEMBLY, G KEY, CLASS

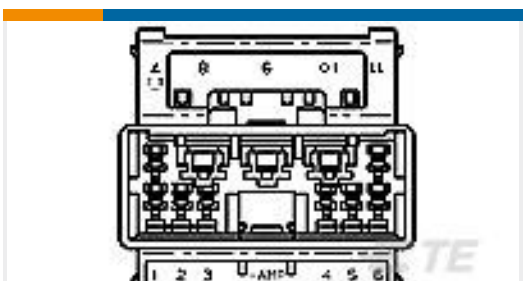

TE Part #174942-1
070 MLC W-W CAP HSG 15P

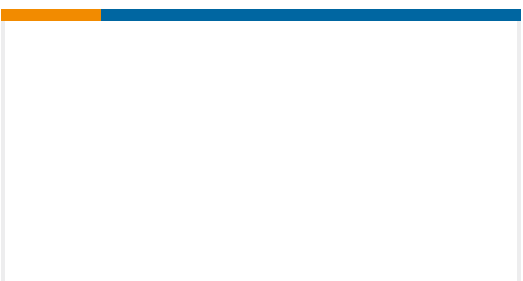

TE Part #2005465-2
PCU SLD 91P PLUG ASSY(A-LH)



TE Part #5-2138685-5
27pos MQS .63 header 180deg

Documents

Product Drawings

[.187 SEALD REC CONT M](#)

English

CAD Files

Customer View Model

[ENG_CVM_175090-1_O1.3d_igs.zip](#)

English

Customer View Model

[ENG_CVM_175090-1_O1.3d_stp.zip](#)

English

Customer View Model

[ENG_CVM_175090-1_O1.2d_dxf.zip](#)

English

3D PDF

English

By downloading the CAD file I accept and agree to the [Terms and Conditions](#) of use.

Datasheets & Catalog Pages

[Econoseal Connector Series](#)

English

Product Specifications

[Application Specification](#)

English

[Crimping of 187 Series, Waterproof Contact](#)

English

[Crimping of Sealed type .060 Receptacle Contact](#)

Japanese

[Application Specification](#)

Japanese

Product Environmental Compliance

[Product Compliance](#)

English

[Product Compliance](#)

English

Instruction Sheets

[060/187 Plug Assy 26Pos. Slide-Type](#)

Japanese

[Instruction Sheet \(U.S.\)](#)

Japanese