

1-480702-0 ✓ ACTIVE

MATE-N-LOK | Universal MATE-N-LOK

TE Internal #: 1-480702-0

Rectangular Power Connectors, Housing, Plug, Wire-to-Board /
Wire-to-Wire, 4 Position, .25 in [6.35 mm] Centerline, Wire & Cable,
Universal MATE-N-LOK

[View on TE.com >](#)



Connectors > Power Connectors > Rectangular Power > Rectangular Power Connectors



Rectangular Power Connector Type: **Housing**

Connector & Housing Type: **Plug**

Connector System: **Wire-to-Board, Wire-to-Wire**

Number of Positions: **4**

Centerline (Pitch): **6.35 mm [.25 in]**

Features

Product Type Features

Rectangular Power Connector Type	Housing
Connector & Housing Type	Plug
Connector System	Wire-to-Board, Wire-to-Wire
Sealable	No
Connector & Contact Terminates To	Wire & Cable

Configuration Features

Number of Positions	4
Number of Power Positions	0
Number of Signal Positions	0
Number of Rows	1

Electrical Characteristics

Operating Voltage	600 VAC
-------------------	---------

Contact Features

Multiple Contact Types	Without
------------------------	---------



Contact Layout	Inline
Contact Retention Within Housing	Without
Contact Type	Socket

Termination Features

Termination Method to Wire & Cable	Crimp
------------------------------------	-------

Mechanical Attachment

Connector Mounting Type	Cable Mount (Free-Hanging)
-------------------------	----------------------------

Housing Features

Centerline (Pitch)	6.35 mm [.25 in]
Housing Color	Natural
Housing Material	Nylon

Usage Conditions

Operating Temperature Range	-55 – 105 °C [-67 – 221 °F]
-----------------------------	-----------------------------

Operation/Application

Assembly Integration Feature	Without
Circuit Application	Power & Signal

Industry Standards

CSA Rating	Certified
UL Flammability Rating	UL 94V-2
Glow Wire Rating	Standard Part - Not Glow Wire
UL Rating	Recognized
Agency/Standard Number	E28476
CSA File Number	LR7189
VDE Tested	Yes
Agency/Standard	CSA, UL

Packaging Features

Packaging Method	Package
Packaging Quantity	1

Other

For Use With	Appropriate Universal MATE-N-LOK Cap or Header
--------------	--

Product Compliance

For compliance documentation, visit the product page on [TE.com](#)>

EU RoHS Directive 2011/65/EU	Compliant
EU ELV Directive 2000/53/EC	Compliant
China RoHS 2 Directive MIIT Order No 32, 2016	No Restricted Materials Above Threshold
EU REACH Regulation (EC) No. 1907/2006	Current ECHA Candidate List: JAN 2022 (223) Candidate List Declared Against: JAN 2022 (223) Does not contain REACH SVHC
Halogen Content	Low Halogen - Br, Cl, F, I < 900 ppm per homogenous material. Also BFR/CFR/PVC Free
Solder Process Capability	Not applicable for solder process capability

Product Compliance Disclaimer

This information is provided based on reasonable inquiry of our suppliers and represents our current actual knowledge based on the information they provided. This information is subject to change. The part numbers that TE has identified as EU RoHS compliant have a maximum concentration of 0.1% by weight in homogenous materials for lead, hexavalent chromium, mercury, PBB, PBDE, DBP, BBP, DEHP, DIBP, and 0.01% for cadmium, or qualify for an exemption to these limits as defined in the Annexes of Directive 2011/65/EU (RoHS2). Finished electrical and electronic equipment products will be CE marked as required by Directive 2011/65/EU. Components may not be CE marked. Additionally, the part numbers that TE has identified as EU ELV compliant have a maximum concentration of 0.1% by weight in homogenous materials for lead, hexavalent chromium, and mercury, and 0.01% for cadmium, or qualify for an exemption to these limits as defined in the Annexes of Directive 2000/53/EC (ELV). Regarding the REACH Regulation, the information TE provides on SVHC in articles for this part number is based on the latest European Chemicals Agency (ECHA) 'Guidance on requirements for substances in articles' posted at this URL: <https://echa.europa.eu/guidance-documents/guidance-on-reach>

Compatible Parts

 <p>TE Part # 926300-1 6P UNIV.M-N-L.PLUG</p>	 <p>TE Part # 350551-6 UMNLSOK 20-14 AU/PHBZ L/P</p>	 <p>TE Part # 350690-2 UMNLS PIN 24-18 AUBR L/P</p>	 <p>TE Part # 926902-3 UNIV-MNL SPLIT ST</p>
--	---	--	---



Also in the Series | **Universal MATE-N-LOK**

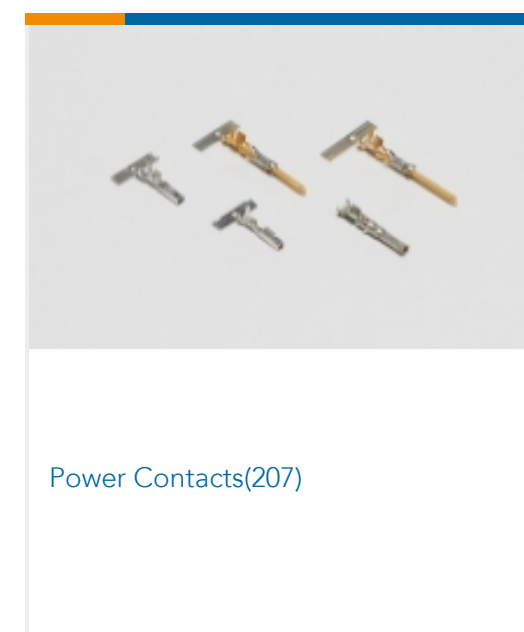
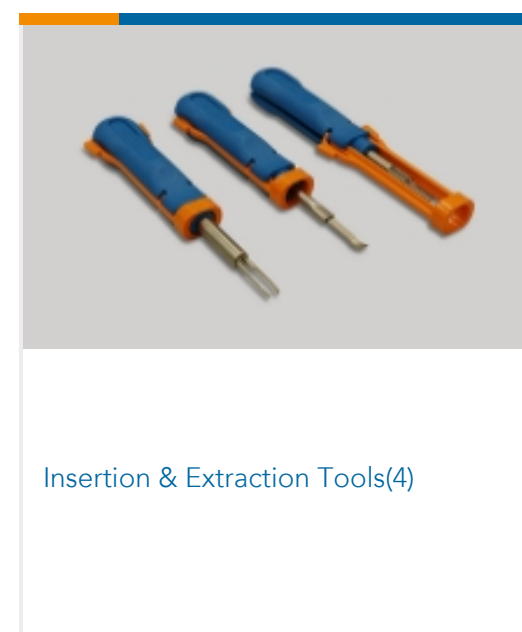
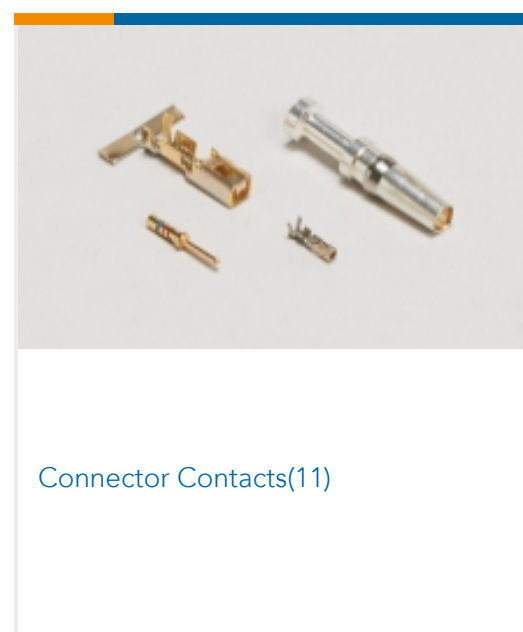
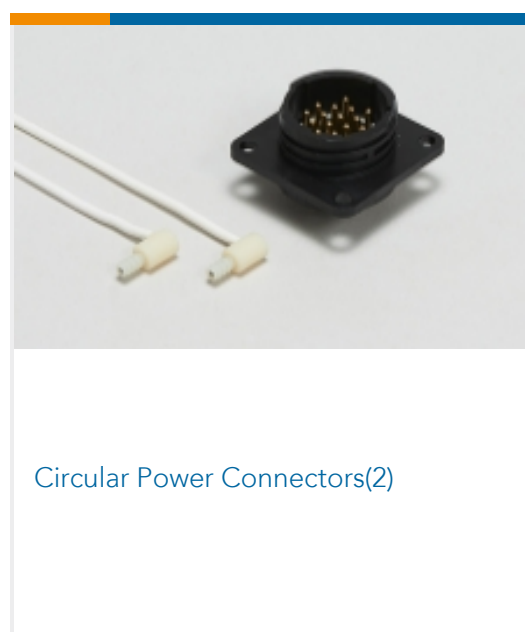

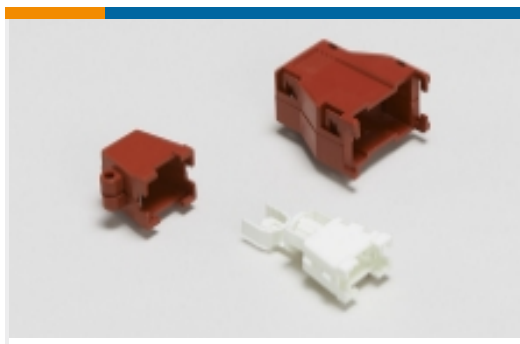

Rectangular Boots & Strain Relief(35)

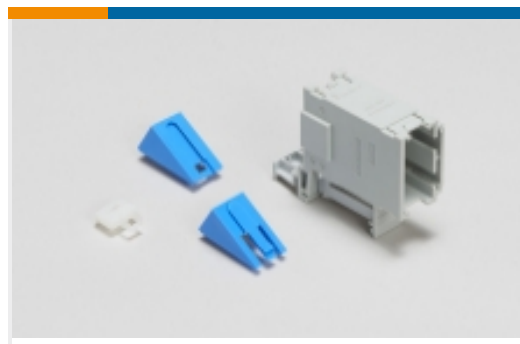

Rectangular Connector Adapters(7)

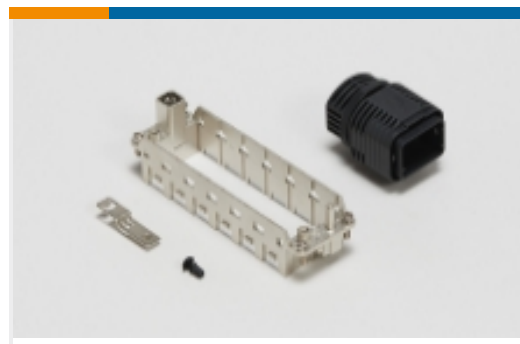

Rectangular Connector Hardware(1)



Rectangular Connector Housings(2)

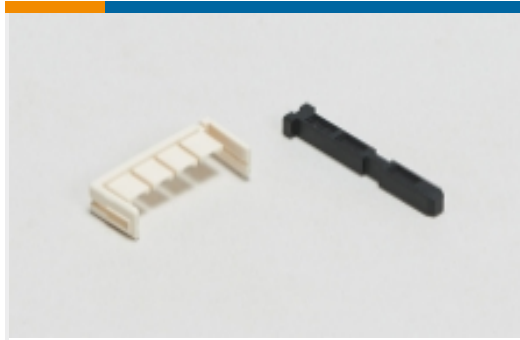

Rectangular Connector Keying Plugs(3)



Rectangular Connector Locking(4)

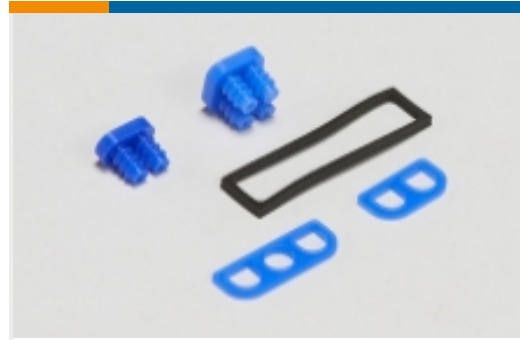

Rectangular Connector Seals(26)



Rectangular Power Connectors(729)

Customers Also Bought

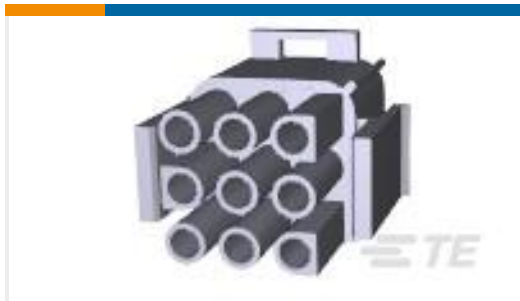

TE Part #1-480706-0
09P UMNL PLUG HSG NATL



TE Part #1-480763-0
05P UMNL PLUG HSG NATL



TE Part #1-480707-0
09P UMNL CAP HSG NATL



TE Part #1-480699-0
02P UMNL CAP HSG NATL



TE Part #1-480708-0
12P UMNL PLUG HSG NATL



TE Part #1-480705-0
06P UMNL CAP HSG NATL



TE Part #1-480704-0
06P UMNL PLUG HSG NATL



TE Part #1-480709-0
12P UMNL CAP HSG NATL



TE Part #1-480701-0
03P UMNL CAP HSG NATL

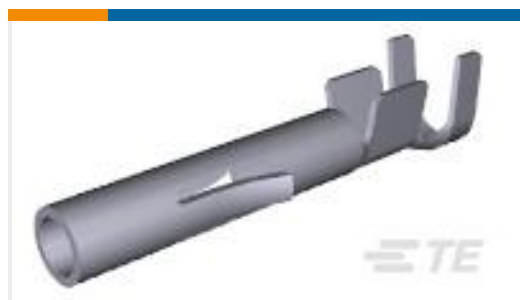

TE Part #350536-1
UMNL SOK 20-14 .0126 PTPBR

Documents



Product Drawings

04P UMNL PLUG HSG NATL

English

CAD Files

3D PDF

3D

Customer View Model

[ENG_CVM_CVM_1-480702-0_BT_c-1-480702-0-bt.2d_dxf.zip](#)

English

Customer View Model

[ENG_CVM_CVM_1-480702-0_BT_c-1-480702-0-bt.3d_igs.zip](#)

English

Customer View Model

[ENG_CVM_CVM_1-480702-0_BT_c-1-480702-0-bt.3d_stp.zip](#)

English

By downloading the CAD file I accept and agree to the [Terms and Conditions](#) of use.

Datasheets & Catalog Pages

SOFT_SHELL_PIN_SOCKET_CONNECTORS_STANDARD_DENSITY

English

Product Specifications

Application Specification

English

Product Environmental Compliance

MD_1-480702-0_07262018836_dmtec

English

MD_1-480702-0_07262018836_dmtec

English

Instruction Sheets

Instruction Sheet (U.S.)

English

Instruction Sheet (U.S.)

English

Agency Approvals

CSA Certificate

English