

1-962340-1 ✓ ACTIVE

AMP | Timer Connector System

TE Internal #: 1-962340-1

Housing for Male Terminals, Wire-to-Wire, 4 Position, .197 in [5 mm] Centerline, Black, Signal, Panel Mount, Key A1, Timer Connector System

[View on TE.com >](#)



Connectors > Automotive Connectors > Connector Housings > TIMER, CONNECTOR HOUSING



Connector & Housing Type: **Housing for Male Terminals**

Mating Tab Width: **2.8 mm [.11 in]**

Connector System: **Wire-to-Wire**

Number of Positions: **4**

Centerline (Pitch): **5 mm [.197 in]**

[All TIMER, CONNECTOR HOUSING \(543\)](#)

Features

Product Type Features

Connector & Housing Shape	Rectangular
Connector & Housing Type	Housing for Male Terminals
Connector System	Wire-to-Wire
Sealable	No
Hybrid Connector	No
Primary Locking Feature	On the Terminal

Configuration Features

Number of Positions	4
Number of Rows	1

Body Features

Body Material	PBT GF
Primary Product Color	Black
Connector Code	A1

Contact Features

Contact Size	2.8mm
Contact Type	Tab
Mating Tab Width	2.8 mm[.11 in]



Mechanical Attachment

Terminal Position Assurance	No
Strain Relief	Without
Mating Alignment Type	Keyed
Mating Alignment	With
Connector Mounting Type	Panel Mount

Housing Features

Centerline (Pitch)	5 mm[.197 in]
--------------------	---------------

Dimensions

Product Width	20.6 mm[.811 in]
Product Length	27.3 mm[1.075 in]
Product Height	38 mm[1.496 in]

Operation/Application

Circuit Application	Signal
---------------------	--------

Packaging Features

Packaging Method	Box
------------------	-----

Other

Serviceable	No
Connector Position Assurance Capable	No

Product Compliance

[For compliance documentation, visit the product page on TE.com>](#)

EU RoHS Directive 2011/65/EU	Compliant
EU ELV Directive 2000/53/EC	Compliant
China RoHS 2 Directive MIIT Order No 32, 2016	No Restricted Materials Above Threshold
EU REACH Regulation (EC) No. 1907/2006	Current ECHA Candidate List: JAN 2022 (223) Candidate List Declared Against: JAN 2022 (223) Does not contain REACH SVHC
Halogen Content	Low Halogen - Br, Cl, F, I < 900 ppm per homogenous material. Also BFR/CFR/PVC Free
Solder Process Capability	Not applicable for solder process capability

Product Compliance Disclaimer

This information is provided based on reasonable inquiry of our suppliers and represents our current actual knowledge based on the information they provided. This information is subject to change. The part numbers that TE has identified as EU RoHS compliant have a maximum concentration of 0.1% by weight in homogenous materials for lead, hexavalent chromium, mercury, PBB, PBDE, DBP, BBP, DEHP, DIBP, and 0.01% for cadmium, or qualify for an exemption to these limits as defined in the Annexes of Directive 2011/65/EU (RoHS2). Finished electrical and electronic equipment products will be CE marked as required by Directive 2011/65/EU. Components may not be CE marked. Additionally, the part numbers that TE has identified as EU ELV compliant have a maximum concentration of 0.1% by weight in homogenous materials for lead, hexavalent chromium, and mercury, and 0.01% for cadmium, or qualify for an exemption to these limits as defined in the Annexes of Directive 2000/53/EC (ELV). Regarding the REACH Regulation, the information TE provides on SVHC in articles for this part number is based on the latest European Chemicals Agency (ECHA) 'Guidance on requirements for substances in articles' posted at this URL: <https://echa.europa.eu/guidance-documents/guidance-on-reach>

Compatible Parts

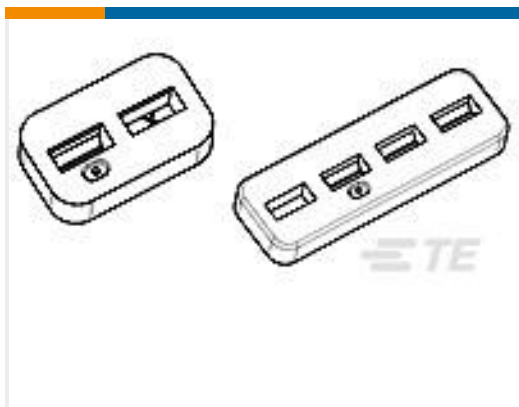

TE Part # 963208-1
Dichtung F4P JPT GH



TE Part # CAT-T4827-CH8172
TIMER, CONNECTOR HOUSING

Also in the Series | Timer Connector System



Automotive Connector Caps & Covers (11)

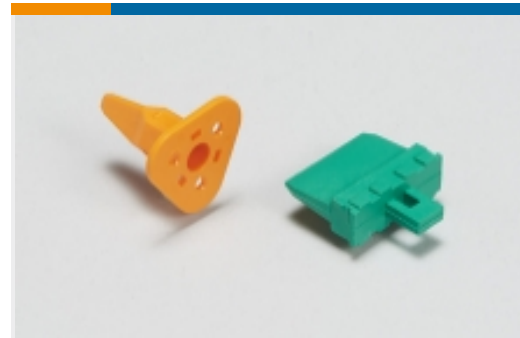

Automotive Connector Locks & Position Assurance(16)



Automotive Housings(219)



Automotive Seals & Cavity Plugs(31)



Automotive Terminals(140)



Crimp Terminal Housings(13)



Insertion & Extraction Tools(20)



Other Automotive Connector Accessories(1)



PCB Headers & Receptacles(78)



Quick Disconnects(4)

Customers Also Bought

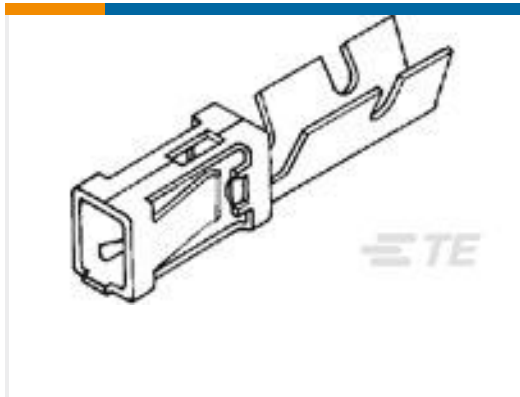
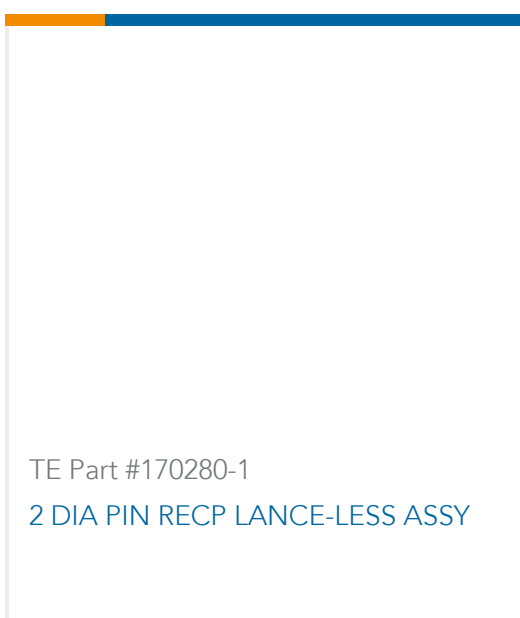
TE Part #281423-1
MODU I REC.TE Part #1-965421-1
TIMER, CONNECTOR HOUSINGTE Part #7-2176387-3
RQ 1206 750K 0.1% 10PPM 1K RLTE Part #172189-1
ECONOSEAL-J FILTER CHIPTE Part #170280-1
2 DIA PIN RECP LANCE-LESS ASSY

Documents

Product Drawings

4P FLACHSTCK GEH2,8

English

CAD Files

3D PDF

English

Customer View Model

[ENG_CVM_1-962340-1_H1.2d_dxf.zip](#)

English

Customer View Model

[ENG_CVM_1-962340-1_H1.3d_igs.zip](#)

English

Customer View Model

[ENG_CVM_1-962340-1_H1.3d_stp.zip](#)

English

By downloading the CAD file I accept and agree to the [Terms and Conditions](#) of use.



Datasheets & Catalog Pages

Timer Interconnection System

English

Product Environmental Compliance

MD_1-962340-1_0813201637_dmtec

English

MD_1-962340-1_0813201637_dmtec

English