

1-962919-1 ✓ ACTIVE

AMP | Timer Connector System

TE Internal #: 1-962919-1

Automotive Terminals, Tab, Mating Tab Width 5.8 mm [.228 in], Tab Thickness .031 in [.8 mm], 11 AWG Wire Size, 4 mm² Wire Size, Timer Connector System

[View on TE.com >](#)



Terminals & Splices > Automotive Terminals > TIMER, RECEPTACLE AND TAB

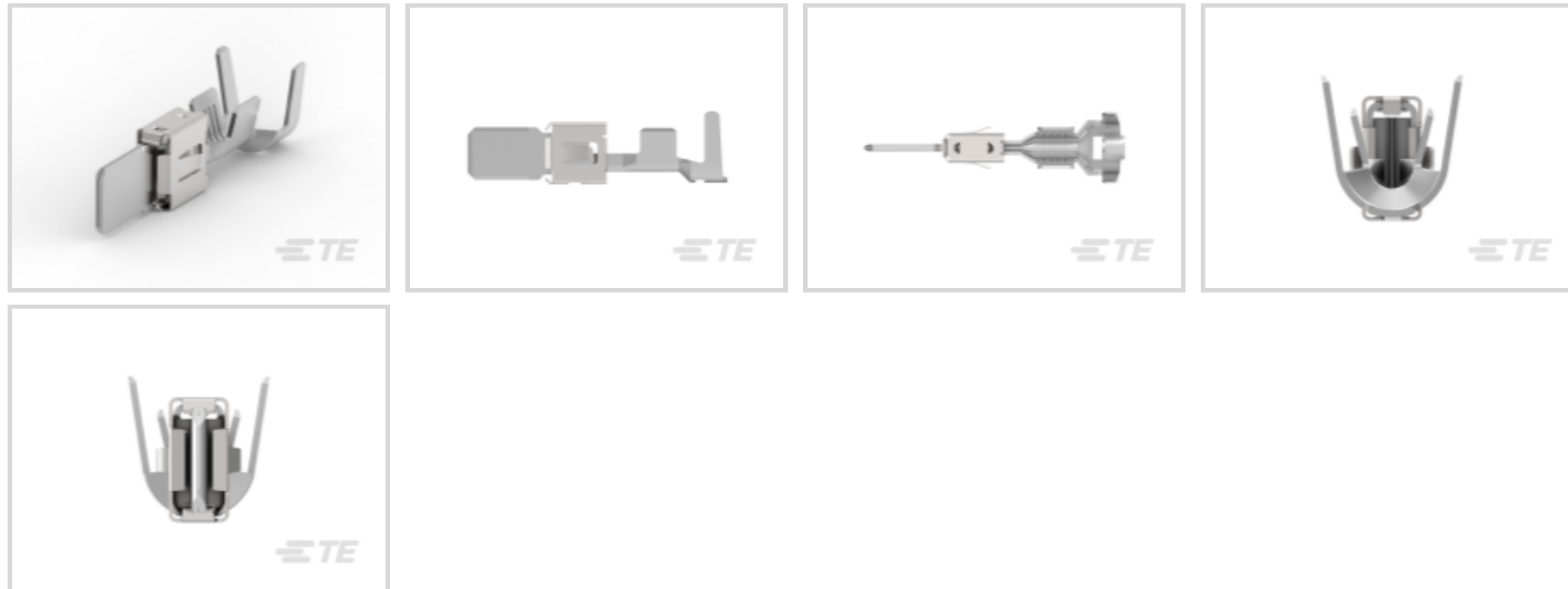

Terminal Type: **Tab**

Mating Tab Width: **5.8 mm [.228 in]**

Mating Tab Thickness: **.8 mm [.031 in]**

Terminal Transmits: **25 – 40 A (Power)**

Wire Size: **11 AWG**

[All TIMER, RECEPTACLE AND TAB \(346\)](#)

Features

Product Type Features

Sealable	Yes
Primary Locking Feature	Locking Lance

Body Features

Terminal Seal Type	Single Wire Seal (SWS)
--------------------	------------------------

Contact Features

Typical Current Rating	40 A
Crimp Type	F-Crimp
Terminal Type	Tab
Mating Tab Width	5.8 mm[.228 in]
Mating Tab Thickness	.8 mm[.031 in]
Interface Plating	Tin (Sn)
Contact Termination Area Plating Material	Tin (Sn)



Termination Features

Termination Method to Wire & Cable	Crimp
Product Terminates To	Wire

Dimensions

Wire Size	4 mm ²
Wire Size Search	11 AWG
Wire Insulation Diameter	3.4 – 3.7 mm [.236 in]

Usage Conditions

Insulation Option	Uninsulated
Operating Temperature (Max)	80 °C, 85 °C, 90 °C, 100 °C, 105 °C, 110 °C, 120 °C, 125 °C, 130 °C [176 °F][185 °F][194 °F][212 °F][221 °F][230 °F][248 °F][257 °F][266 °F]
Operating Temperature Range	-40 – 130 °C [-40 – 266 °F]

Operation/Application

Compatible With Wire Base Material	Copper
------------------------------------	--------

Packaging Features

Packaging Method	Reel
Packaging Quantity	1500

Other

Terminal Transmits	25 – 40 A (Power)
--------------------	-------------------

Product Compliance

[For compliance documentation, visit the product page on TE.com>](#)

EU RoHS Directive 2011/65/EU	Compliant
EU ELV Directive 2000/53/EC	Compliant
China RoHS 2 Directive MIIT Order No 32, 2016	No Restricted Materials Above Threshold
EU REACH Regulation (EC) No. 1907/2006	Current ECHA Candidate List: JAN 2022 (223) Candidate List Declared Against: JAN 2022 (223) Does not contain REACH SVHC
Halogen Content	Low Halogen - Br, Cl, F, I < 900 ppm per homogenous material. Also BFR/CFR/PVC Free

Solder Process Capability

Not applicable for solder process capability

Product Compliance Disclaimer

This information is provided based on reasonable inquiry of our suppliers and represents our current actual knowledge based on the information they provided. This information is subject to change. The part numbers that TE has identified as EU RoHS compliant have a maximum concentration of 0.1% by weight in homogenous materials for lead, hexavalent chromium, mercury, PBB, PBDE, DBP, BBP, DEHP, DIBP, and 0.01% for cadmium, or qualify for an exemption to these limits as defined in the Annexes of Directive 2011/65/EU (RoHS2). Finished electrical and electronic equipment products will be CE marked as required by Directive 2011/65/EU. Components may not be CE marked. Additionally, the part numbers that TE has identified as EU ELV compliant have a maximum concentration of 0.1% by weight in homogenous materials for lead, hexavalent chromium, and mercury, and 0.01% for cadmium, or qualify for an exemption to these limits as defined in the Annexes of Directive 2000/53/EC (ELV). Regarding the REACH Regulation, the information TE provides on SVHC in articles for this part number is based on the latest European Chemicals Agency (ECHA) 'Guidance on requirements for substances in articles' posted at this URL: <https://echa.europa.eu/guidance-documents/guidance-on-reach>

Compatible Parts



TE Part # CAT-H3399-CH8172
Heavy Duty Sealed Connector Series Housings



TE Part # 4-1579007-3
EXTRACTION TOOL KIT



TE Part # 1-1579007-6
EXTRACTION TOOL



TE Part # 2305570-1
TERMINAL CUTTER, SIDE FEED



TE Part # 1897213-2
MCP 6.3 2P CAP HSG



TE Part # CAT-L489-CH8172
LEAVYSEAL HOUSINGS



TE Part # CAT-M4595-CH8172
MCON, CONNECTOR HOUSING



TE Part # 2-1564536-1
4POS,TAB5.8X0.8,TABHSG,ASSY, COD. B



TE Part # 2-2151782-2
OCEAN_2.0_APPLICATOR-S-130F2600



TE Part # 2-2837905-2
APPLICATOR TO MAKE LOOSE PIECE TERMINALS



TE Part # 2151782-2
OCEAN_2.0_APPLICATOR-S-130F2600



TE Part # 2837905-2
APPLICATOR TO MAKE LOOSE PIECE TERMINALS

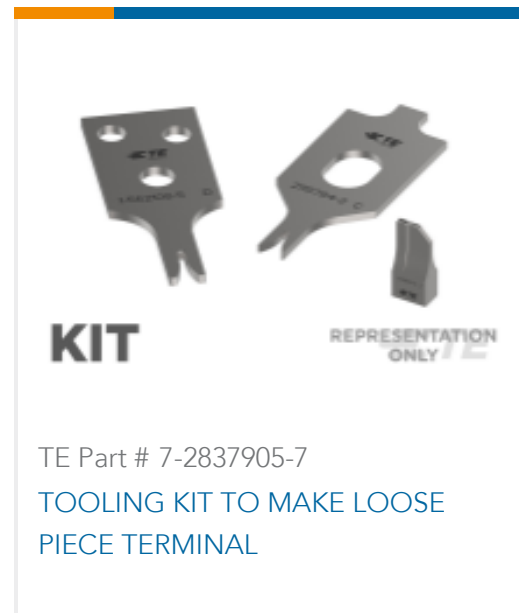

Also in the Series | Timer Connector System

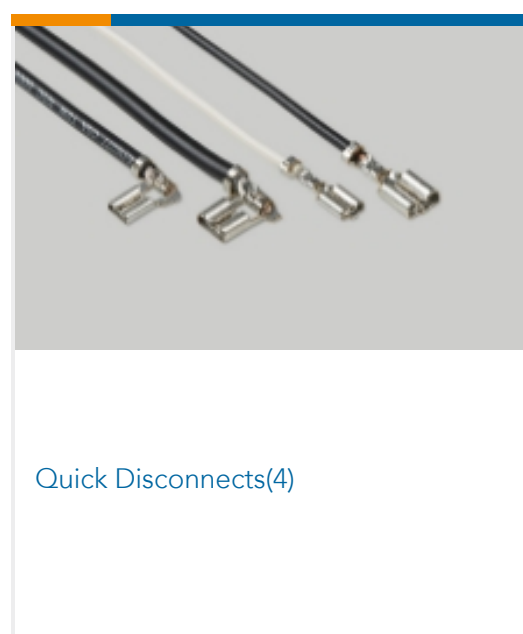
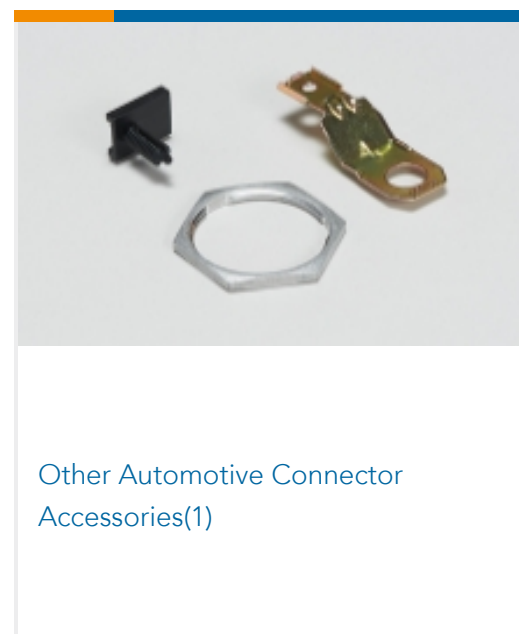
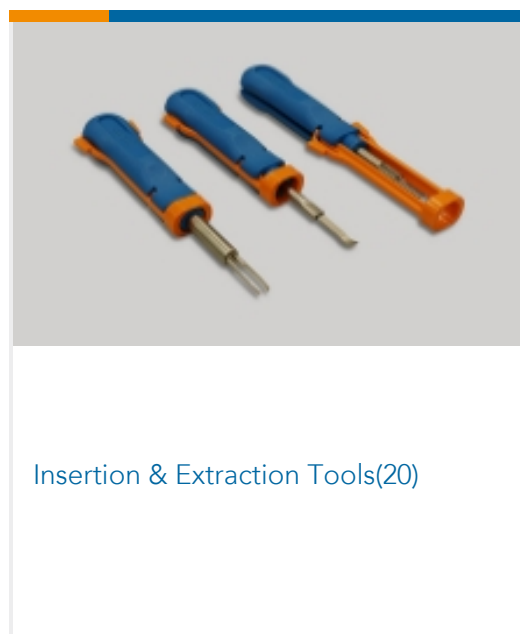
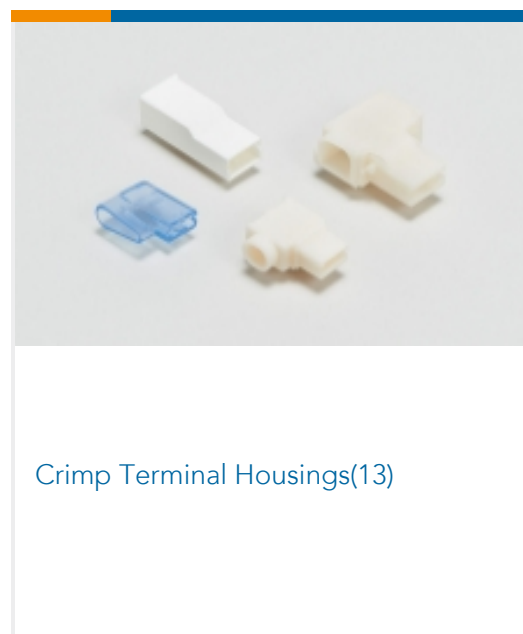
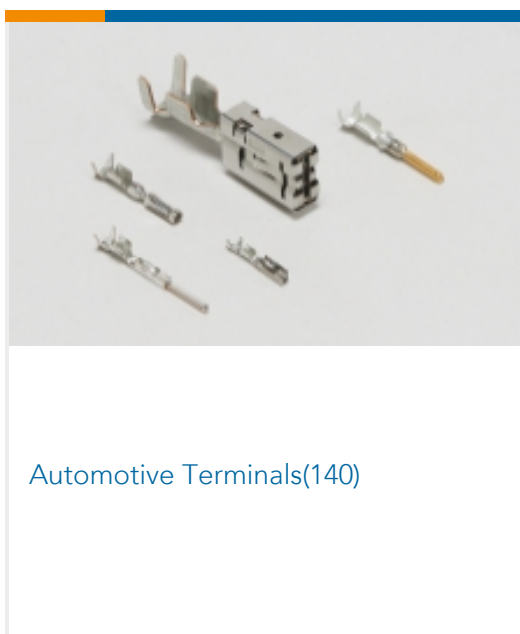
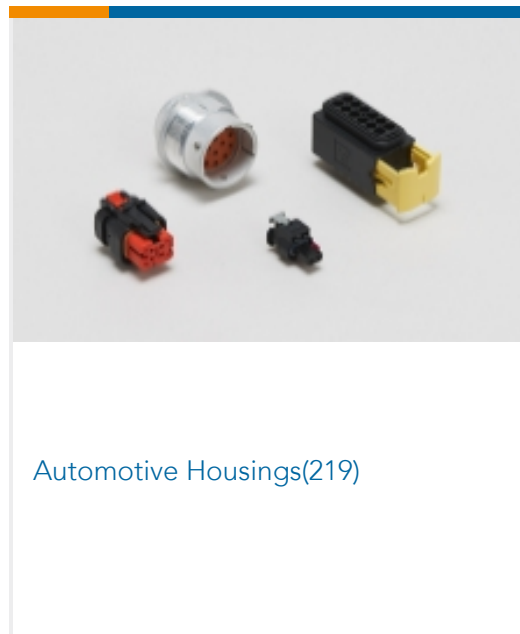
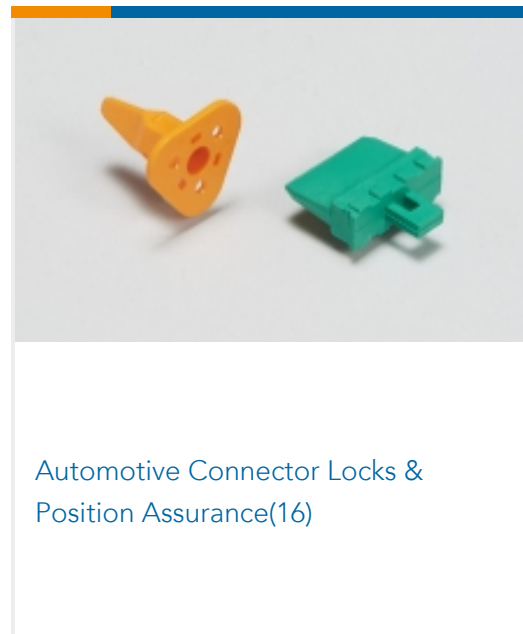
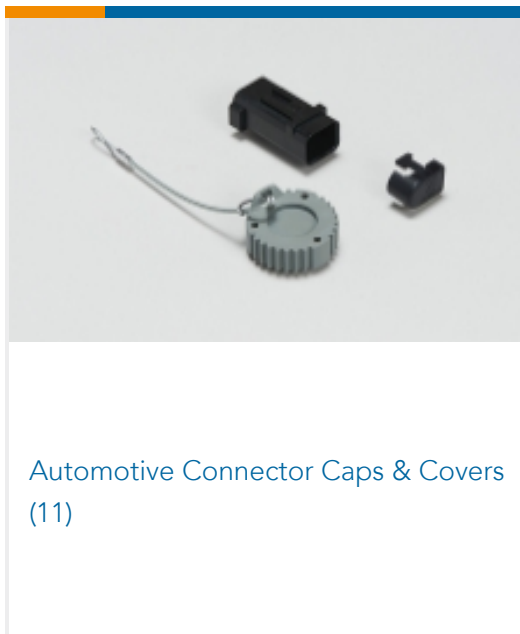

Customers Also Bought



TE Part #1924396-1
14P MCON 1.2 SCCM Inner Housing



TE Part #2272431-1
GET .64 CONNECTOR SYSTEM,
CONNECTOR HSG



TE Part #3-2308295-1
1POS,PCON12,REC HSG,90 DEG,
UNSLD,COD C



TE Part #1564880-1
GET 0.64,FEMALE TERMINAL 0.13M



TE Part #2133662-1
REC CONN CVR ASSY,64POS,MQS



TE Part #771113P005
FL2500-NO.2-19-0-27MM



TE Part #D58196-000
FL2500-NO.2-19-0-50MM



TE Part #1123653-1
.040 3 UNSEALED CONT.REC MS

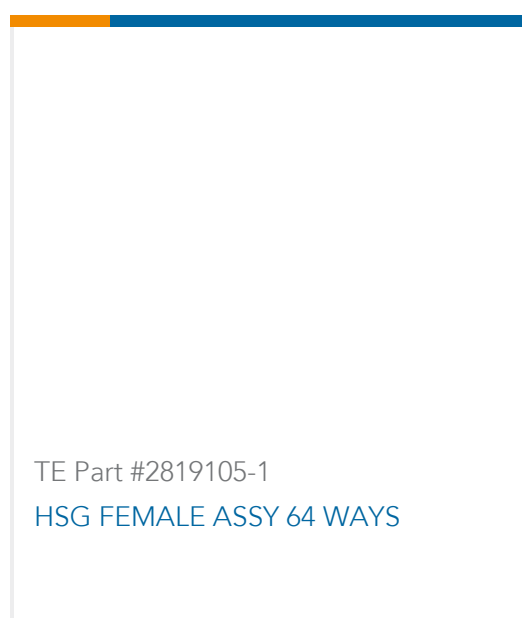

TE Part #2819105-1
HSG FEMALE ASSY 64 WAYS

Documents

Product Drawings

[TAB 5.8x0.8 CONTACT CS SWS Sn](#)

English

[TAB 5.8x0.8 CONTACT CS SWS Sn](#)

English

CAD Files

Customer View Model

[ENG_CVM_1-962919-1_A1.3d_igs.zip](#)

English

Customer View Model

[ENG_CVM_1-962919-1_A1.3d_stp.zip](#)

English

Customer View Model

[ENG_CVM_1-962919-1_A1.2d_dxf.zip](#)

English

[3D PDF](#)

English

By downloading the CAD file I accept and agree to the [Terms and Conditions](#) of use.



Datasheets & Catalog Pages

Timer Interconnection System

English

HDSCS Catalog

English

CONNECTOR SELECTOR

English

Product Specifications

Application Specification

German

Application Specification

English

Application Specification

English

Product Environmental Compliance

Product Compliance

English

Product Compliance

English