

1-967628-1 ✓ ACTIVE

AMP | AMP MCP 2.8, AMP MCP Connector System

TE Internal #: 1-967628-1

Housing for Male Terminals, Wire-to-Wire, 15 Position, .197 in [5 mm] Centerline, Other, Signal, Panel Mount, -40 – 248 °F [-40 – 120 ° C], Hybrid

[View on TE.com >](#)



Connectors > Automotive Connectors > Connector Housings > AMP MCP, UNSEALED CONNECTOR HOUSING

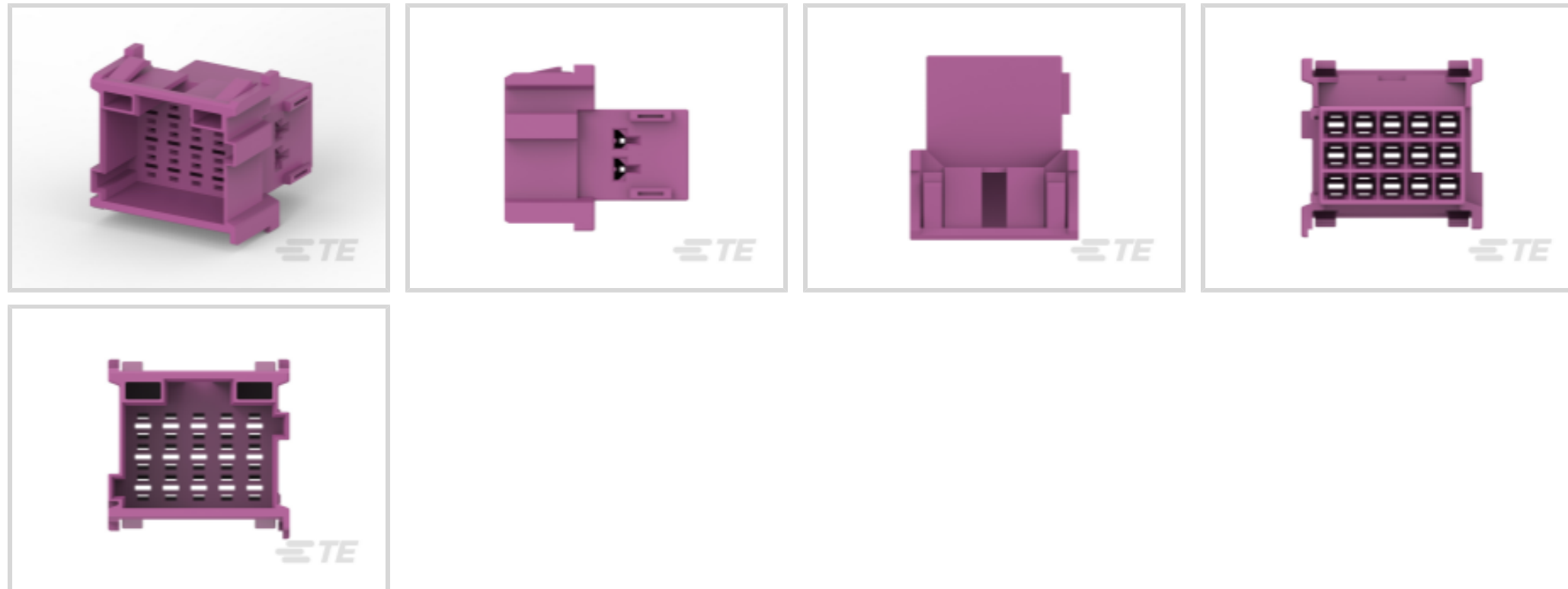

Connector & Housing Type: **Housing for Male Terminals**

Mating Tab Width: **2.8 mm [.11 in]**

Connector System: **Wire-to-Wire**

Number of Positions: **15**

Centerline (Pitch): **5 mm [.197 in]**

[All AMP MCP, UNSEALED CONNECTOR HOUSING \(187\)](#)

Features

Product Type Features

Connector & Housing Shape	Rectangular
Connector & Housing Type	Housing for Male Terminals
Connector System	Wire-to-Wire
Sealable	No
Hybrid Connector	No
Primary Locking Feature	On the Terminal

Configuration Features

Number of Positions	15
Number of Rows	3

Electrical Characteristics

Operating Voltage	28 VDC
Nominal Voltage Architecture	12 V, 24 V



Body Features

Cable Exit Angle	180°
Body Material	PA GF
Primary Product Color	Other
Connector Code	A

Contact Features

Contact Size	2.8mm
Contact Type	Tab
Mating Tab Width	2.8 mm[.11 in]

Mechanical Attachment

Mounting Feature	Without
Terminal Position Assurance	No
Strain Relief	Without
Mating Alignment Type	Keyed
Mating Alignment	With
Connector Mounting Type	Panel Mount

Housing Features

Centerline (Pitch)	5 mm[.197 in]
--------------------	---------------

Dimensions

Product Width	35.45 mm[1.396 in]
Product Length	32.5 mm[1.28 in]
Product Height	30.6 mm[1.205 in]

Usage Conditions

Operating Temperature (Max)	70 °C, 75 °C, 80 °C, 85 °C, 90 °C, 100 °C, 105 °C, 110 °C, 120 °C[158 °F][167 °F][176 °F][185 °F][194 °F][212 °F][221 °F][230 °F][248 °F]
Operating Temperature Range	-40 – 120 °C[-40 – 248 °F]

Operation/Application

Circuit Application	Signal
---------------------	--------

Packaging Features

Packaging Method	Bag
------------------	-----

Other



Serviceable	No
Connector Position Assurance Capable	No

Product Compliance

[For compliance documentation, visit the product page on TE.com>](#)

EU RoHS Directive 2011/65/EU	Compliant
EU ELV Directive 2000/53/EC	Compliant
China RoHS 2 Directive MIIT Order No 32, 2016	No Restricted Materials Above Threshold
EU REACH Regulation (EC) No. 1907/2006	Current ECHA Candidate List: JAN 2022 (223) Candidate List Declared Against: JAN 2022 (223) Does not contain REACH SVHC
Halogen Content	BFR/CFR/PVC Free, but Br/Cl >900 ppm in other sources.
Solder Process Capability	Not applicable for solder process capability

Product Compliance Disclaimer

This information is provided based on reasonable inquiry of our suppliers and represents our current actual knowledge based on the information they provided. This information is subject to change. The part numbers that TE has identified as EU RoHS compliant have a maximum concentration of 0.1% by weight in homogenous materials for lead, hexavalent chromium, mercury, PBB, PBDE, DBP, BBP, DEHP, DIBP, and 0.01% for cadmium, or qualify for an exemption to these limits as defined in the Annexes of Directive 2011/65/EU (RoHS2). Finished electrical and electronic equipment products will be CE marked as required by Directive 2011/65/EU. Components may not be CE marked. Additionally, the part numbers that TE has identified as EU ELV compliant have a maximum concentration of 0.1% by weight in homogenous materials for lead, hexavalent chromium, and mercury, and 0.01% for cadmium, or qualify for an exemption to these limits as defined in the Annexes of Directive 2000/53/EC (ELV). Regarding the REACH Regulation, the information TE provides on SVHC in articles for this part number is based on the latest European Chemicals Agency (ECHA) 'Guidance on requirements for substances in articles' posted at this URL: <https://echa.europa.eu/guidance-documents/guidance-on-reach>

Compatible Parts



TE Part # CAT-T4827-CH8172
TIMER, CONNECTOR HOUSING



TE Part # 8-968973-1
MCP2.8 GEH 15P



TE Part # CAT-T4827-T273
TIMER, RECEPTACLE AND TAB



TE Part # 967633-1
2. KONT-SICHERUNG 15P



Also in the Series | **AMP MCP 2.8**

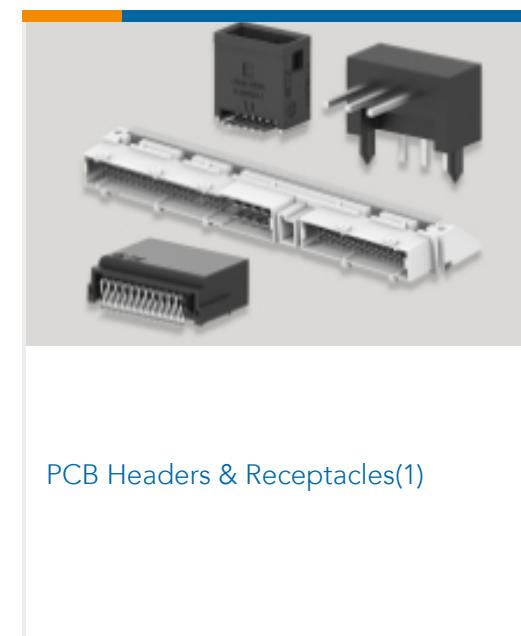
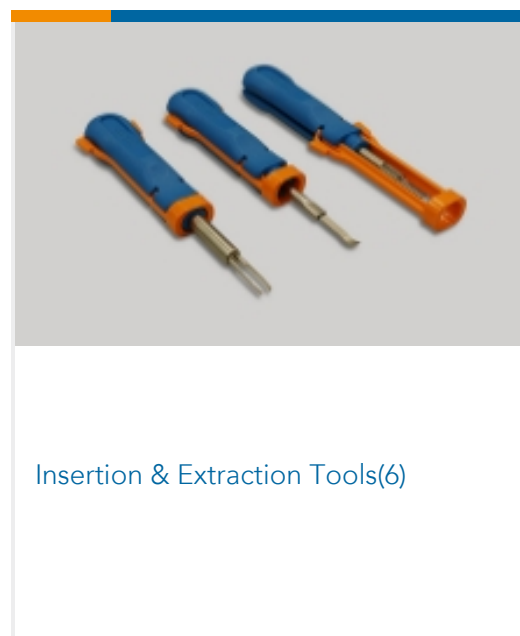
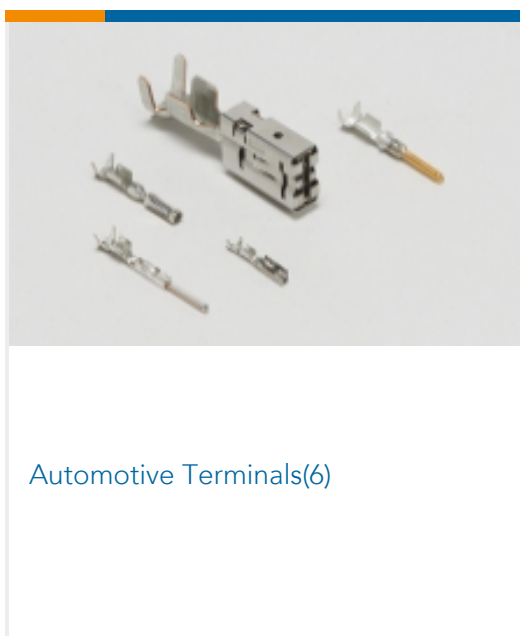
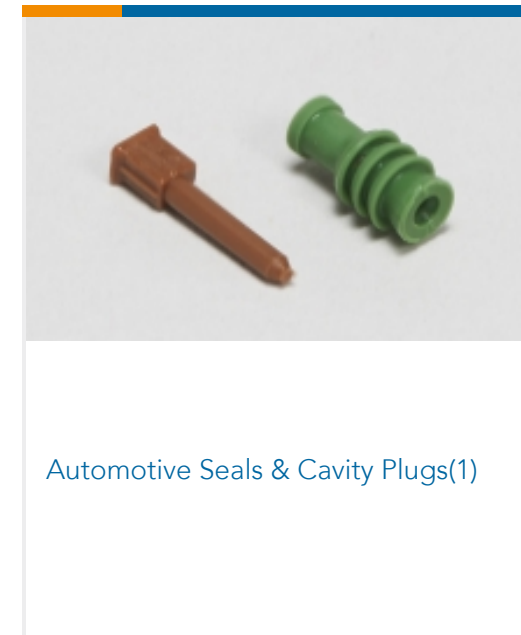
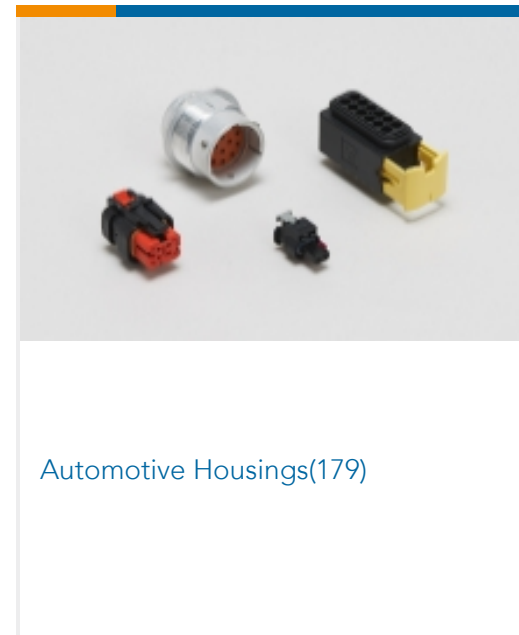
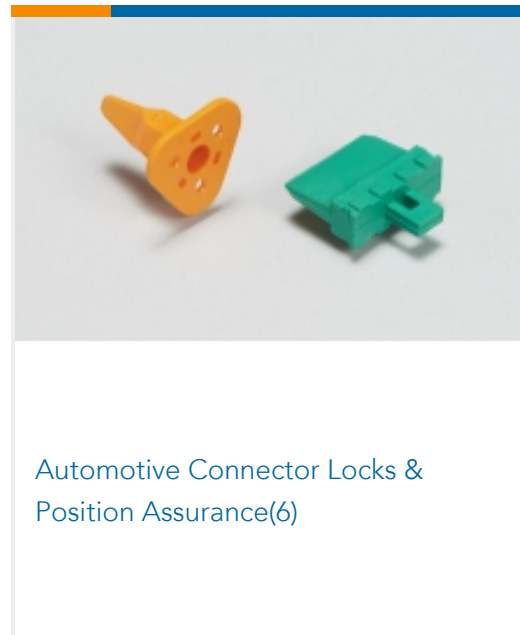
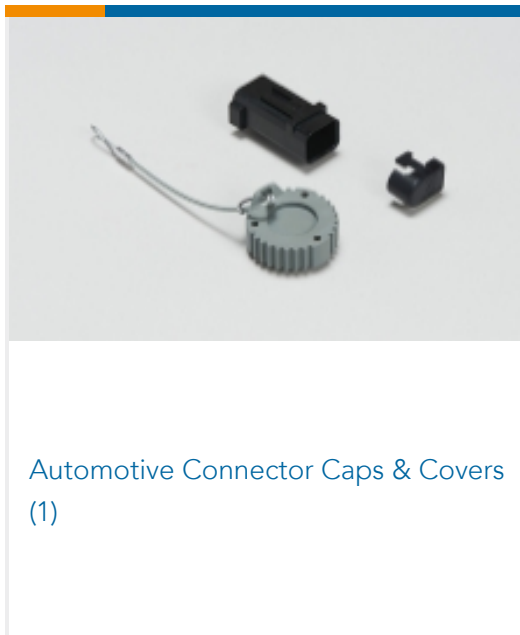

Also in the Series | **AMP MCP Connector System**

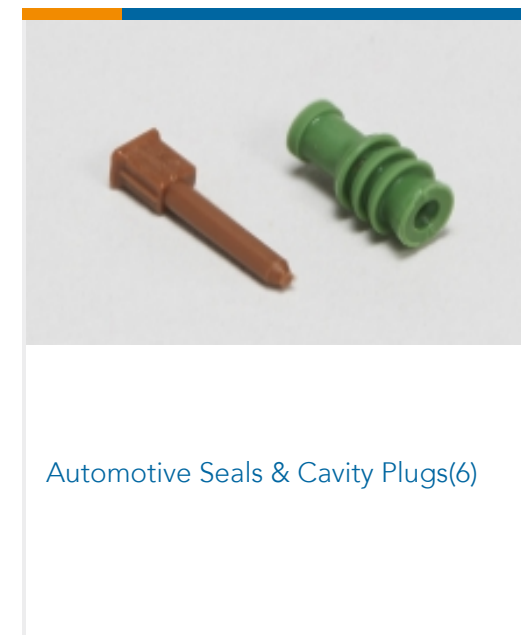
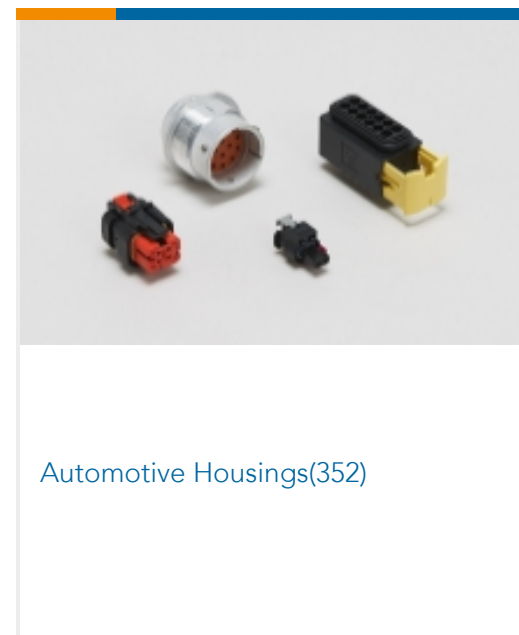
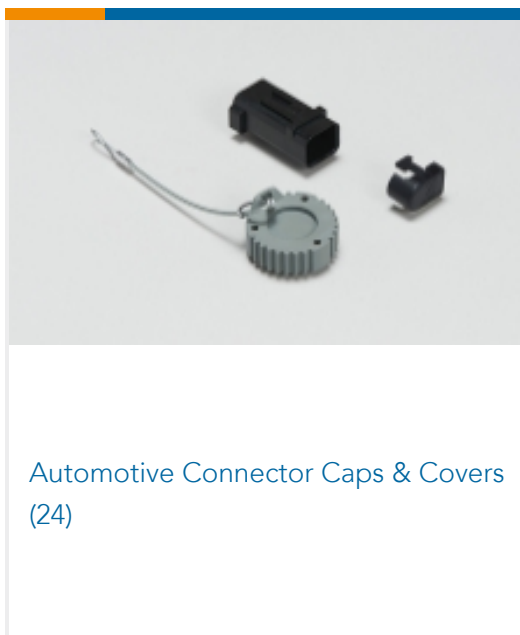



Automotive Terminals(125)



Insertion & Extraction Tools(13)

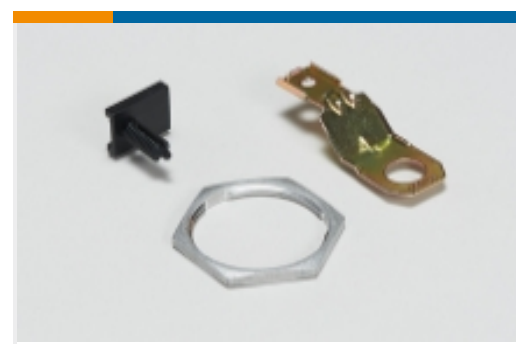

Other Automotive Connector Accessories(2)

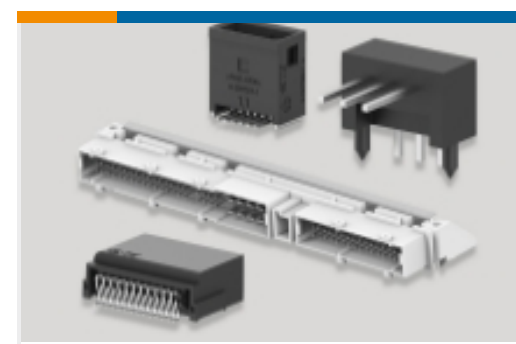

PCB Headers & Receptacles(29)

Customers Also Bought

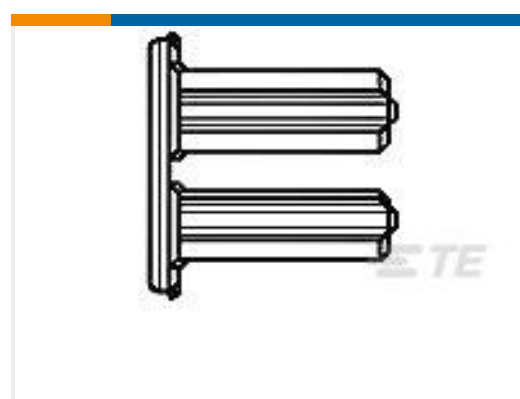
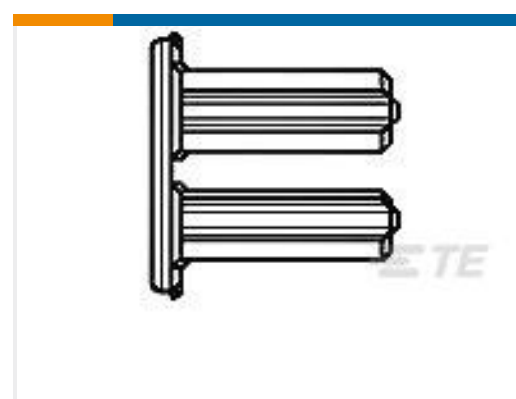
TE Part #2-2364571-0
AVH19 FLT SS LK RNG BLU 24V26ATE Part #1-2364570-9
AVH19 FLT SS MT RNG BLU 24V16ATE Part #1-967623-1
TIMER, CONNECTOR HOUSINGTE Part #1-967627-1
AMP MCP, UNSEALED CONNECTOR HOUSINGTE Part #1-2303812-2
DT04-2P-TN31, REC, 2P, GRY, N,
SNAPCAPTE Part #967631-1
2. KONT-SICHERUNG 9PTE Part #967632-1
2. KONT-SICHERUNG 12P

Documents

Product Drawings

[FLA-ST-GEH 2.8 15P](#)

English

[FLA-ST-GEH 2.8 15P](#)

English

CAD Files

Customer View Model

[ENG_CVM_CVM_1-967628-1_E.2d_dxf.zip](#)

English

[3D PDF](#)

3D

Customer View Model

[ENG_CVM_CVM_1-967628-1_E.3d_igs.zip](#)

English

Customer View Model

[ENG_CVM_CVM_1-967628-1_E.3d_stp.zip](#)



English

By downloading the CAD file I accept and agree to the [Terms and Conditions](#) of use.

Product Specifications

Application Specification

English

Product Environmental Compliance

MD_1-967628-1_10042017719_dmtec

English

MD_1-967628-1_10042017719_dmtec

English