



**Multilock Connector System**

TE Internal #: 1-1743089-3

Housing for Female Terminals, Wire-to-Wire, 39 Position, .157 in / .098 in [2.5 mm / 4 mm] Centerline, Gray, Power, Multilock Connector System

[View on TE.com >](#)

Connectors > Automotive Connectors > Connector Housings > MULTILOCK, CONNECTOR HOUSING

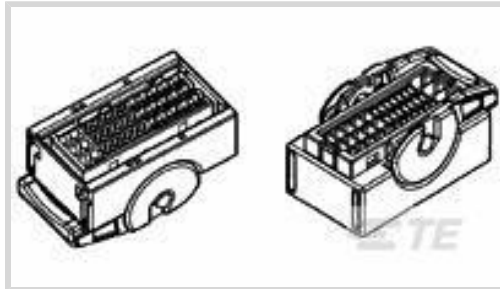

Connector & Housing Type: **Housing for Female Terminals**

Mating Tab Width: **1 mm, 2.28 mm, 6.35 mm [ .04 in, .09 in, .25 in ]**

Connector System: **Wire-to-Wire**

Number of Positions: **39**

Centerline (Pitch): **2.5 mm, 4 mm [ .098 in, .157 in ]**

[All MULTILOCK, CONNECTOR HOUSING \(576\)](#)

**Features**

**Product Type Features**

Connector & Housing Shape	Rectangular
Connector & Housing Type	Housing for Female Terminals
Connector System	Wire-to-Wire
Sealable	No
Hybrid Connector	Yes
Primary Locking Feature	Integrated in Housing

**Configuration Features**

Number of Positions	39
Number of Rows	3

**Body Features**

Cable Exit Angle	180°
Body Material	PBT GF
Primary Product Color	Gray

**Contact Features**

Contact Size	1mm, 2.3mm, 6.3mm
Contact Type	Receptacle
Mating Tab Width	1 mm, 2.28 mm, 6.35 mm [.04 in][.09 in][.25



in]

### Mechanical Attachment

Mounting Feature	Without
Terminal Position Assurance	No
Strain Relief	Without
Mating Alignment Type	Polarization Slot
Mating Alignment	With
Connector Mounting Type	Cable Mount (Free-Hanging)

### Housing Features

Centerline (Pitch)	2.5 mm, 4 mm [.098 in] [.157 in]
--------------------	----------------------------------

### Dimensions

Product Width	28.2 mm [1.11 in]
Product Length	60.5 mm [2.38 in]
Product Height	32.6 mm [1.28 in]
Row-to-Row Spacing	5.2 mm [.204 in]

### Operation/Application

Circuit Application	Power
---------------------	-------

### Packaging Features

Packaging Quantity	42
Packaging Method	Tray

### Other

Serviceable	No
Connector Position Assurance Capable	No

### Product Compliance

[For compliance documentation, visit the product page on TE.com>](#)

EU RoHS Directive 2011/65/EU	Compliant
EU ELV Directive 2000/53/EC	Compliant
China RoHS 2 Directive MIIT Order No 32, 2016	No Restricted Materials Above Threshold
EU REACH Regulation (EC) No. 1907/2006	Current ECHA Candidate List: JAN 2022 (223) Candidate List Declared Against: JAN 2021 (211)



SVHC > Threshold:  
Not Yet Reviewed

Halogen Content

Low Halogen - Br, Cl, F, I < 900 ppm per homogenous material. Also BFR/CFR/PVC Free

Solder Process Capability

Not applicable for solder process capability

Product Compliance Disclaimer

This information is provided based on reasonable inquiry of our suppliers and represents our current actual knowledge based on the information they provided. This information is subject to change. The part numbers that TE has identified as EU RoHS compliant have a maximum concentration of 0.1% by weight in homogenous materials for lead, hexavalent chromium, mercury, PBB, PBDE, DBP, BBP, DEHP, DIBP, and 0.01% for cadmium, or qualify for an exemption to these limits as defined in the Annexes of Directive 2011/65/EU (RoHS2). Finished electrical and electronic equipment products will be CE marked as required by Directive 2011/65/EU. Components may not be CE marked. Additionally, the part numbers that TE has identified as EU ELV compliant have a maximum concentration of 0.1% by weight in homogenous materials for lead, hexavalent chromium, and mercury, and 0.01% for cadmium, or qualify for an exemption to these limits as defined in the Annexes of Directive 2000/53/EC (ELV). Regarding the REACH Regulation, the information TE provides on SVHC in articles for this part number is based on the latest European Chemicals Agency (ECHA) 'Guidance on requirements for substances in articles' posted at this URL: <https://echa.europa.eu/guidance-documents/guidance-on-reach>

### Compatible Parts



TE Part # 927824-1  
SPT REC 6.3 Contact SRC Sn



TE Part # CAT-M9194-T273  
MULTILOCK, RECEPTACLE AND TAB

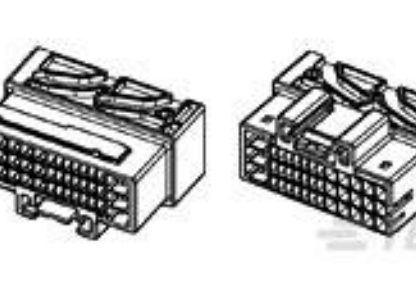

TE Part # 1-1743086-3  
LIF HYB 39P CAP ASSY GRAY

### Also in the Series | Multilock Connector System



Automotive Connector Caps & Covers  
(16)



Automotive Connector EMC Shielding  
(1)



Automotive Connector Locks & Position Assurance(2)

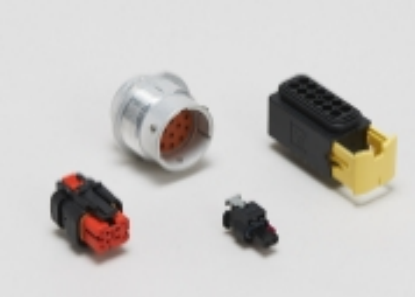

Automotive Housings(575)



Automotive Seals &amp; Cavity Plugs(2)



Automotive Terminals(141)



Insertion &amp; Extraction Tools(6)

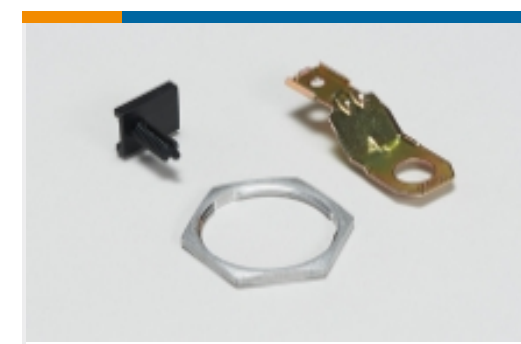

Other Automotive Connector Accessories(9)



PCB Headers &amp; Receptacles(129)

## Customers Also Bought

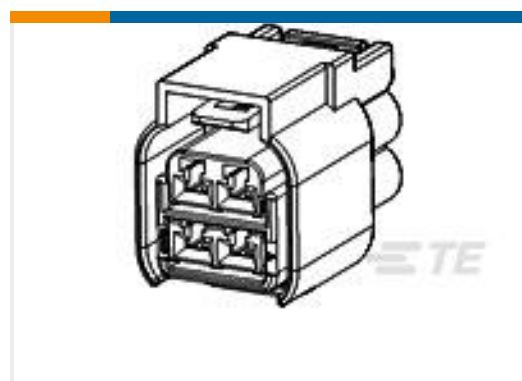
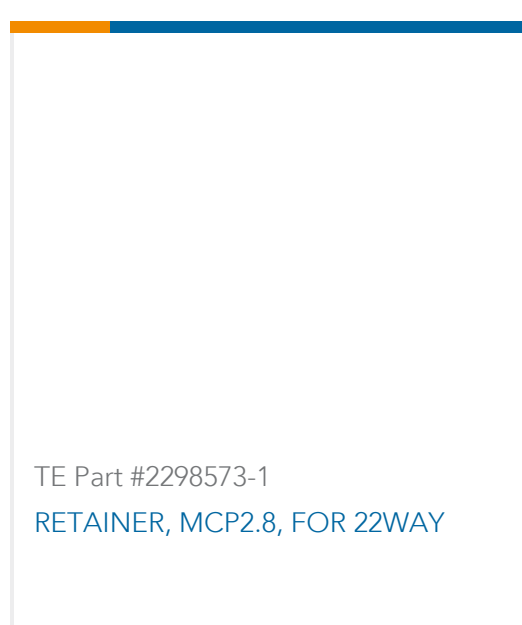
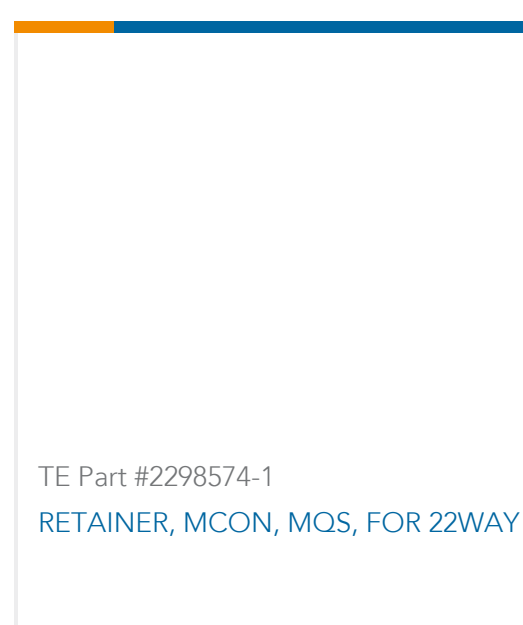
TE Part #936254-2  
MCP-E SLD 4P PLUG ASSY BLKTE Part #936196-1  
MULTILOCK, CONNECTOR HOUSINGTE Part #284224-2  
MQS, CONNECTOR HOUSINGTE Part #2278586-1  
67 POS COVER ASSY TYPE180TE Part #2298573-1  
RETAINER, MCP2.8, FOR 22WAYTE Part #2298574-1  
RETAINER, MCON, MQS, FOR 22WAYTE Part #2324321-1  
025 REC CONTACT

## Documents

### Product Drawings

[LIF HYB 39P PLUG ASSY GRY](#)

English

### CAD Files

[Customer View Model](#)

[ENG\\_CVM\\_CVM\\_1-1743089-3\\_O.2d\\_dxf.zip](#)

English

[3D PDF](#)



3D

Customer View Model

[ENG\\_CVM\\_CVM\\_1-1743089-3\\_O.3d\\_igs.zip](#)

English

Customer View Model

[ENG\\_CVM\\_CVM\\_1-1743089-3\\_O.3d\\_stp.zip](#)

English

By downloading the CAD file I accept and agree to the [Terms and Conditions](#) of use.

**Datasheets & Catalog Pages**

[MULTILOCK Connector System](#)

English